

Fencing with Wildlife in Mind





“Good fences make good neighbors.”

—Robert Frost, from *Mending Walls*

A Conversation Starter, Not the Last Word

Fences—thousands of types have been invented, and millions of miles have been erected. We live our lives between post, rail, chain link and wire. It’s difficult to imagine neighborhoods, farms, industry and ranches without fences. They define property, confine pets and livestock, and protect that which is dear to us, joining or separating the public and private. For humans, fences make space into place. For wildlife, fences limit travel and access to critical habitat.

This publication provides guidelines and details for constructing fences with wildlife in mind. The information it contains has been contributed by wildlife managers, biologists, land managers, farmers, and ranchers. Over time, their observations and research have built a body of knowledge concerning wildlife and fences, including:

- A basic understanding of how ungulates cross fences and the fence designs that cause problems for moose, elk, deer, pronghorn, and bighorn sheep.
- Fence designs that adequately contain livestock without excluding wildlife.
- Fence designs that effectively exclude ungulates, bears, beavers, and other small mammals.

This information is intended to open the conversation about fences and wildlife. This is by no means the “last word.” New fencing materials and designs are continually developed. New research on the topic will invariably provide added and improved alternatives. Nonetheless, this publication provides viable options to those who wish to allow safe passage for wildlife or to exclude animals for specific reasons. Talk to your neighbors, other experienced landowners, and staff at land and natural resource management agencies. Find out what has worked, or not, from others who have built or repaired fences to address wildlife-related issues.

Note: Colorado is a “fence out” state, meaning that, if you don’t want someone else’s livestock on your property, it is your responsibility to fence them out. It is not the owner’s responsibility to keep livestock fenced in. In place since the early 1880s, Colorado’s law of the land is different from many regions in the United States. Current Colorado fence law is found in the Colorado Revised Statutes (35-46-101 CRS).

Many local governments have enacted fencing ordinances and require permits in order to put up fences. If you are considering erecting a fence, please contact your local land use permitting authority for information on local rules and regulations.

Table of Contents

Fencing with Wildlife in Mind	2
Problem Fences	3
Do You Really Need a Fence?	5
Considerations for Fence Design	5
Wildlife-Friendly Fencing	6
Visibility	6
Livestock Fencing	8
Fencing for Horses	18
Openings, Crossings, and Passes	20
Remedies for Existing Fences	28
Exclusion Fencing	29
Getting Help	34
Sources.....	36
Colorado Parks and Wildlife Offices	Inside Back Cover

Acknowledgements

First and foremost, thanks are due to Christine Page of Ravenworks Ecology, E.R. Jenne Illustration and Montana Fish, Wildlife and Parks for allowing us to use portions of text and illustrations from their 2008 guide *A Landowner's Guide to Wildlife Friendly Fences* in this publication. It is always a privilege to build on the work of other state wildlife agencies.

Many Colorado Parks and Wildlife employees assisted in gathering photos, providing information, and recommending landowners to profile: Chad Bishop, Kelly Crane, Lance Gatlin, Travis Harris, Liza Hunholz, Tom Kroening, Tom Martin, Terry Mathieson, Ken Morgan, JT Romatzke, Michael Seraphin, Lyle Sidener, Pat Tucker, Garrett Watson, and Casey Westbrook. Thanks also to HPP Committee Administrative Assistants Karen Kieborz and Danielle Lemon.

Funds to print this guide were contributed by the Colorado Parks and Wildlife Habitat Partnership Program (HPP) and Game Damage Section as well as the US Fish and Wildlife Service Partners for Fish and Wildlife Program.

Author

Wendy Hanophy, Golden, CO
wendyhanophy1@comcast.net

Graphic Design

Department of Personnel & Administration
Division of Central Services,
Integrated Document Solutions (IDS) Design

Front Cover Photo

©Wes Uncapher

Back Cover Photo

©Richard Seeley

Illustrations

©E.R. Jenne Illustration, Missoula, MT
edjenne@earthlink.net

Citation

Hanophy, W. 2009. *Fencing with Wildlife in Mind*. Colorado Parks and Wildlife, Denver, CO. 36 pp

Fencing with Wildlife in Mind

Between 1842 and 1853, legendary explorer John C. Frémont completed five extraordinary expeditions through Colorado. He journeyed thousands of miles, mapping promising routes to move people and goods from east to west. An ardent naturalist, he described the rich abundance of wildlife he encountered along the way. His journals tell of abundant big game. He saw elk, deer, bison, pronghorn and bighorn sheep. There were encounters with black and grizzly bear, wolf, coyote, and mountain lion. Frémont noted the historic migration routes traveled by game and the native hunters who tracked them—all unfettered paths through an open landscape.

Twenty-first century Colorado bears little resemblance to Frémont's account. Today's landscape is fragmented with subdivisions, roads and dams, business parks, ski areas,

and farms and ranches. Viewed from above, Colorado's grasslands, mountains, canyons, and plateaus look like an elaborate quilt; each piece outlined with barbed-wire, woven-wire, jackleg and other fences. Our economy and our future depend upon these developments, but each has an impact on wildlife and its habitat. Wildlife must travel across landscapes to find food, shelter and water. Fences, coupled with human development and loss of habitat, can contribute to needless wildlife death. Fences act as a barrier to daily movement and seasonal migration of wildlife. Also, animals and birds can be injured or killed when they collide with fences or get tangled in wires. Most people would prevent these needless deaths if only they knew how.

Fences are needed for a variety of purposes: to delineate property boundaries, to contain livestock and pets, to prevent trespass, and to protect apiaries, gardens, haystacks, and homes. No one will argue that fences aren't

needed. But not only can fences be barriers and traps for wildlife, animal damage to fences can also be costly and frustrating for landowners. Fencing is expensive. It takes time to construct a good fence. It takes more time to maintain a fence or chase down livestock that have escaped through a broken fence. You can save money in the long run by fencing in only what you need to protect and leaving access to the habitat that animals need. Where fence is necessary, you can tailor design and placement to minimize the impact on wildlife and lessen your costs and time to fix it.

This publication provides recommendations for wildlife-friendly fencing and specifications for many common fence types and applications. It includes a list of resources for those who need further detail. Several Colorado landowners are profiled—people whose livelihood depends on fences to protect their interests. We hope their successes will prompt others to put up **or take down** fences—with wildlife in mind.



PHOTO BY TERRY MATHIESON, CPW



PHOTO BY LANCE GATLIN, CPW



PHOTO BY LANCE GATLIN, CPW

Loose fence and mesh netting are easily entangled in antlers.

(Below) Elk, deer, and other ungulates can suffer a slow, painful death if their legs get tangled in fences.

Problem Fences

What kinds of fence cause problems for wildlife?
Fences that:

- are too high to jump;
- are too low to crawl under;
- have loose wires;
- have wires spaced too closely together;
- are difficult for fleeing animals or birds to see;
- create a complete barrier.

Deer, elk, moose, bighorn sheep, and pronghorn are all capable of jumping many fences, but smooth or barbed-wire can snag animals and tangle legs, especially if wires are loose or spaced too closely together. Deer and elk jump with their hind legs forward. If the top strands are too high, too close together, or are loose, they will often get hung up. If animals can't pull free, they die a slow and desperate death. Even when animals do clear fences, or crawl through or under the strands, they often bear countless scars from wire barbs.

Some fences, especially woven wire, can be a complete barrier to fawns and calves, even if adults can still jump over. Separated from their mothers, stranded and unable to follow the herd, the youngsters can be killed by predators or cars or simply die of starvation. If woven wire is topped with one or more strands of barbed-wire, the fence becomes a complete barrier for animals that are incapable or unwilling to jump and are too large to slip through. Animals trying to leap a woven-wire/barbed-wire fence are even more likely to tangle a leg between the top barbed-wire and the stiff woven wire.



PHOTO BY GARETT WATSON, CPW

Birds can collide with fences, breaking wings, impaling themselves on barbs, and tangling in wires. Large, low-flying birds such as ducks, geese, cranes, grouse, hawks, and owls are especially vulnerable. Waterfowl fly into fences that run near or across waterways, and low-flying hawks and owls may careen into fences when swooping in on prey.

Jackleg or buck and rail fences are sometimes considered wildlife-friendly, but they are usually built too high, too wide and with rails placed too closely together for animals to cross or crawl through. The three-dimensional jackleg



Woven-wire fence, especially if topped with barbed wire, is the most lethal fence to wildlife.

PHOTO BY PAT TUCKER, CPW

design is especially hard to leap over, and if jackleg is combined with woven or barbed-wire or placed on steep terrain, it presents an almost complete barrier to ungulates and other large animals.

Antlered animals can become fatally tangled in poly rope fence and loose barbed-wire. Maintaining fence tension and using high-tensile wire for electric fences prevents such tragedies.

Problems arise when adjacent landowners both erect fences. Jackleg fence combined with barbed-wire fence presents a barrier to wildlife.



PHOTO BY PAT TUCKER, CPW

Just the Facts

Recently, researchers at Utah State University completed a study of wildlife mortality along more than 600 miles of fences in the rangelands of northeastern Utah and northwestern Colorado (Harrington 2005, Harrington and Conover 2006). By repeatedly driving and walking fence lines over two seasons, they tallied the number of mule deer, pronghorn and elk carcasses they found caught in fences and lying next to fences. They also studied which fence types caused the most problems. Here are their key findings:

- On average, one ungulate per year was found tangled for every 2.5 miles of fence.
- Most animals (69% of juveniles and 77% of adults) died by getting caught in the top two wires while trying to jump a fence.
- Juveniles are eight times more likely to die in fences than adults.
- Mortalities peaked during August, when fawns are weaned.
- Woven-wire fence topped with a single strand of barbed-wire was the most lethal fence type; ungulate's legs are easily snared and tangled between the barbed-wire and rigid woven-wire.
- 70% of all mortalities were on fences higher than 40".
- On average, one ungulate was found dead next to, but not in fences, every 1.2 miles of fence; most were found next to woven-wire fence.
- 90% of carcasses found near fences were fawns—separated from their mothers and unable to cross.

Do You Really Need a Fence?

While the best fence for wildlife is no fence at all, fences are a necessity. Fences contain or exclude livestock, and protect crops, hives, play yards, gardens, dog runs and other property. In some cases, though, there are good alternatives to fences. People, especially those new to mountain and foothill communities, tend to put up fencing along their property lines. If the property contains important habitat and the fence excludes wildlife, the animals lose food, water, resting areas, and travel corridors.

There are many creative ways to define boundaries, discourage trespass, or maintain privacy. A line of trees, shrubs, and other vegetation can be used to mark a boundary, screen for privacy, beautify your landscape, and provide additional food and cover for wildlife. The areas that wildlife choose as travel corridors are often the same places that you would want to preserve in a natural state to retain the scenic amenities and aesthetic value of your property. You could also consider marking property boundaries with signs, flexible fiberglass or plastic boundary posts, or fence posts spaced at intervals without cross-wires. If you only fence the portions of your property that you need to protect, you'll be saving time, money, and wildlife.

To prevent access by vehicles, consider using bollards—short stout barrier posts. They can define a driveway or parking area, or edge a lawn or field. Posts can be spaced closely together or placed farther apart and connected with a heavy chain, cable or rail. Bollards can be made of wood, concrete, brick, stone, cast iron, aluminum, or steel. A row of evenly spaced boulders serves the same function.



CPW FILE PHOTO

Consider wildlife-friendly alternatives to fences to mark boundaries.

Considerations for Fence Design

If a fence is needed, please consider fence placement and designs that minimize the impact on wildlife. This guide will help you tailor your fences to your specific needs, keep construction and maintenance costs down, and still allow wildlife access to water, important habitats, and travel corridors.

Purpose of the Fence

The purpose of the fence will often dictate which type of fence to use. Are you trying to keep livestock in or keep wildlife out? Is the fence needed year-round or only seasonally? Would temporary fences suit your purposes, or is permanent fencing required?

Wildlife Habitat

Wherever possible, design your fence to provide wildlife free travel to important habitats and corridors, as well as access to water. Wetlands and riparian habitats are especially important for all wildlife.

Species of Wildlife Present and Wildlife Use of the Land

Note the wildlife you see in the area. Which species may need to cross the fence? Watch for daily and seasonal wildlife movement patterns and look for trails. Talk to CPW staff, former and current landowners, and neighbors. Would sections of fence cross known game trails? Would the planned fence separate wildlife from their accustomed water source, food source, fawning/calving ground, or security cover? Design property boundary fences so wildlife can easily cross, or provide gaps or lay-down sections for wildlife passage whenever livestock is not present. Provide wildlife access

to riparian habitats, water holes and other high quality habitats. Place crossings, jumps, open gates and other wildlife openings in appropriate locations. Deer, elk, and pronghorn are more likely to use openings at fence corners than in the middle of a fence run, unless there is cover, habitat or natural corridors or trails to attract them through. Intermittent openings should be placed where animals naturally travel: in riparian corridors, along gullies and ridges, and on existing game trails.

Topography

Work with your land's topography. Are you fencing on hills, in rocky country where posts cannot be driven, or near or across streams or wetlands? Will your fence be a topography trap for wildlife? Swales, gullies, ridges and

stream corridors can funnel wildlife through an area—keep these open to allow wildlife passage and avoid topography traps.

A fence of any height is more difficult to cross when placed across a steep slope. As ground slope increases, the distance an animal must jump to clear the fence increases considerably (see illustration below). For instance, a 42" fence may be passable on level ground, but a slope of only 10% increases the effective fence height to 48.6"; a slope of 30% increases effective height to 62", and on a 50% slope animals encounter an obstacle 75" high. Fences on steep slopes become nearly impossible for animals to jump without injury.

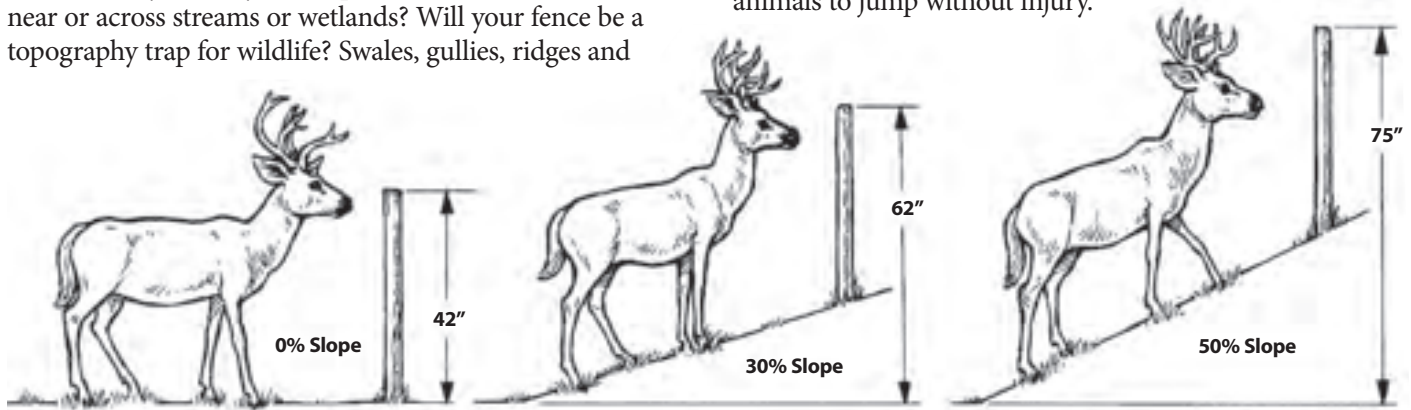

Wildlife-Friendly Fencing

The ideal wildlife-friendly fence:

- Is highly visible to ungulates and birds
- Allows wildlife to jump over or crawl under
- Provides wildlife access to important habitats and travel corridors

The “friendliest” fences for wildlife are very visible and allow wild animals to easily jump over or slip under the wires or rails. The Colorado Division of Parks and Wildlife recommends:

- Fencing wire placed on the side of the fence posts where the domestic animals are located;
- Smooth wire or rounded rail for the top, smooth wire on the bottom;
- Height of top rail or wire should be 42" or less;
- At least 12" between the top two wires;
- At least 16" between the bottom wire or rail and the ground;

- Posts at minimum 16' intervals;
- Gates, drop-downs, removable fence sections or other passages where animals concentrate and cross;
- Using a rail, high-visibility wire, flagging or other visual markers for the top.

Visibility

High visibility helps wildlife negotiate fences. Visibility is especially important in grasslands and near creeks and wetlands to protect low-flying birds, such as grouse, owls and waterfowl. For big game, increased visibility helps animals judge their jumps better so that they can clear the fence or use another location to cross. Using a vinyl coated high-tensile wire for the top wire, or covering the existing top wire with PVC pipe, flagging, or tape helps wildlife see fences and dramatically reduces wildlife damage to fences of all heights. Another solution is using a rounded top rail, which will shed snow easily.

For wire fences, the least expensive solution is to simply hang flagging, or other materials along the top, although many materials can fade or be lost and need regular replacement. Another alternative is to slip sections of small diameter PVC pipe over the top strand. High-

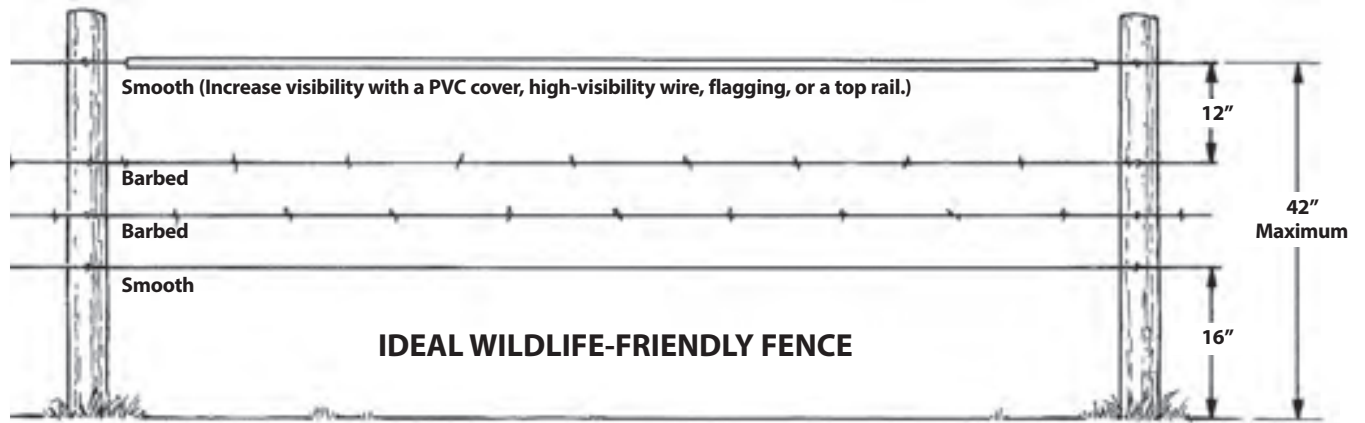

visibility wire is also available in many forms—tape, braid, and polymer-coated wire—many of which can be electrified if needed. White wire is thought to be the most visible to wildlife.

Many landowners have found that other colors of wire work just as well as white wire. In Jackson County, Jim Baller installed a fence with a black high-tensile coated top wire. He has found that the thicker wire and the fence's wooden stays are very visible to elk.

In other locations in Colorado, land managers have had success with green, brown, and yellow wire.



PHOTO BY WENDY HANOPHY



PHOTO BY GARETT WATSON, CPW

killed by 60 percent. They have been experimenting with vinyl siding strips attached with reflective tape, which appears very bright to birds. Additional study is underway to determine the most effective markers and fence designs for sage-grouse.



PHOTO BY TOM CHRISTIANSEN, WYOMING GAME AND FISH DEPARTMENT

Many species of grouse frequently collide with fences. Fence markers may be needed where grouse species concentrate. Landowners and public land managers should consider marking fences near leks and also in high-use nesting, brood-rearing, and late summer, fall, and winter habitat. Researchers with the Wyoming Game and Fish Department documented 146 collisions of sage-grouse on or near a 4.7 mile section of barbed-wire fence in western Wyoming during a 31-month period. They found that placing colored tags on the fence to make the wire more visible seemed to reduce the number of birds

Low-flying sage-grouse frequently collide with fences.

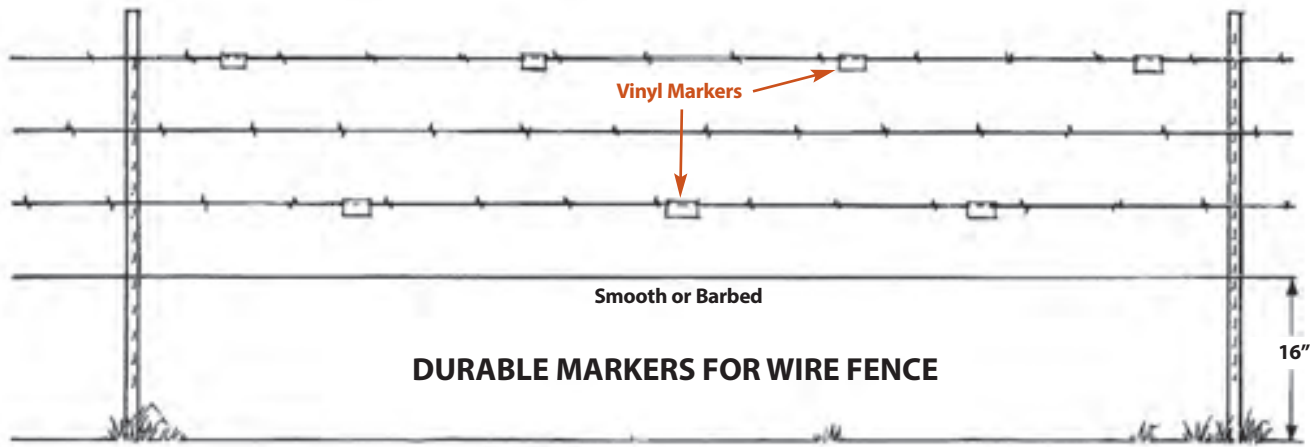

The Sutton Avian Research Center in Oklahoma uses “undersill” or trim strips of white vinyl siding cut into 3” pieces to mark fences for lesser prairie chickens. This may also work well for other grouse species. The undersill siding strips have a lip that can be snapped onto barbed-

wire fence, and the vinyl strips can be easily cut with tin snips or a miter saw. The siding pieces are lightweight and durable, and the fence can be marked quickly and easily. Place at least four pieces on the top wire per fence section, and three pieces on the middle wire per section.

Livestock Fencing

A livestock control fence can keep your livestock within your property or adjacent livestock off. There are different fence configurations for keeping cattle, horses, sheep or other livestock from wandering. Not all situations require a four strand barbed-wire or woven-wire fence. Smooth wire fence, various types of post and rail fences, and temporary or moveable electric fences can be used for seasonal pastures, horse pastures and many other situations with low or intermittent livestock use. Even sites with high or continuous livestock use can be served well by a combination of smooth and barbed-wire, high-tensile, or electric fence.

Fencing costs are one of the most expensive aspects of livestock grazing. The type of fence constructed greatly impacts the cost per foot as well as the total cost of the fence. For both wildlife and your wallet, it is best to fence just enough to address your situation. Fence types from most to least wildlife-friendly are:

- 3-wire all smooth
- 3-wire top and bottom smooth
- 4-wire all smooth
- 4-wire top and bottom smooth
- 4-wire barbed with bottom smooth
- 4-wire all barbed
- Woven wire with a top smooth wire
- Woven wire with a top barbed wire



PHOTO BY TOM KROENIG, CPW

Fawns and calves have a particularly difficult time crossing barbed-wire fence.

3-Strand Smooth Wire Fence

Use three strands of smooth (barbless) wire. High-tensile wire is effective for light livestock control.

- Top wire 40 to 42” high;
- Center wire 30” above the ground;
- Bottom wire a minimum of 16” above the ground;
- Preferably, no vertical stays;
- Wood or steel posts at 16 or 16.5’ intervals.

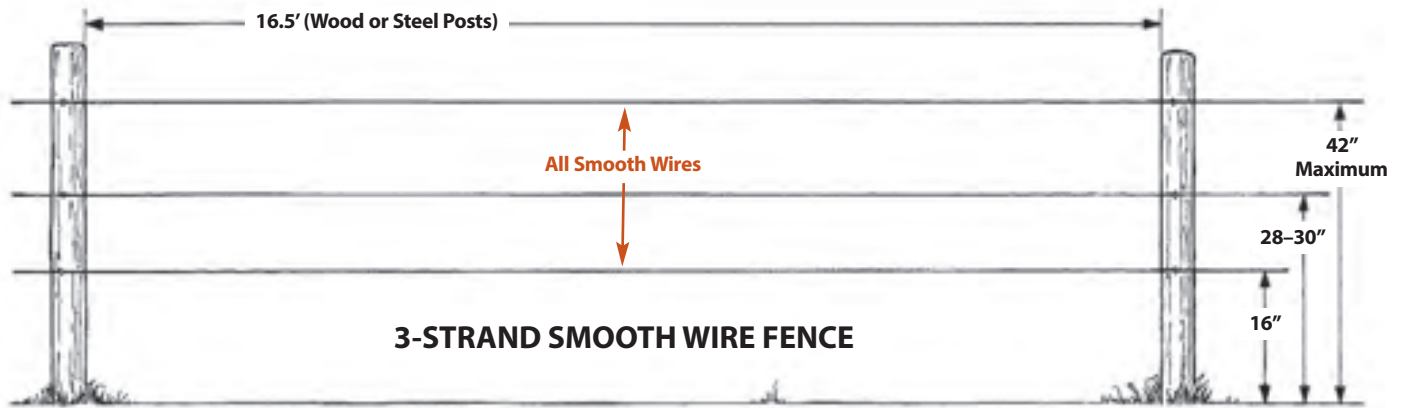

Combination Smooth and Barbed-Wire Fence

In many situations, a combination of smooth wire and barbed-wire can effectively contain livestock and allow for easier wildlife passage. Smooth wire can be used for the top and bottom wires and one to two barbed-wire strands are used for the center strands. High-tensile wire can be used on top, and poly-coated white high-tensile wire will increase visibility for wildlife.

- Place top smooth wire at 40 to 42” maximum height—high-tensile or poly-coated white high-tensile wire is recommended;
- Allow at least 12” between top and second wires;
- Place bottom smooth wire at least 16” from the ground;
- Use barbed-wire for center two wires.

In most cases, it is possible to use a smooth bottom wire on 4-strand fences. This type of fence controls livestock but still allows for passage of pronghorn, deer, and elk.



PHOTO BY TERRY MATHIESON, CPW

What about Sheep?

In Colorado, the most traditional fence used to contain sheep is a 32” woven wire fence topped with two strands of barbed wire. The woven wire definitely keeps the sheep in, but can present an impenetrable barrier for elk, deer, and pronghorn calves. In Wyoming, ranchers have had great success using a combination of smooth and barbed wire to contain sheep or both cattle and sheep on deer and pronghorn range. To contain sheep, the bottom wire is lower, 10” above ground, and there is less distance between the top two wires. The top wire is also lower, so that it is easier for deer and elk to jump. Sheep ranchers who are constructing or replacing fence may want to try these designs. However, if the fence will also function as a state highway right-of-way, be sure that it follows CDOT fencing policy. Go to the CDOT web site and search for “2006 Fence Standards.”

<https://www.codot.gov>

Sheep and Cattle 4-Strand Barbed-wire Fence

(Wyoming Game and Fish Department Recommendations)

	Recommended Wire Heights Above the Ground		
	Cattle	Sheep	Cattle and Sheep
Top wire	40–42” Barbed	32” Barbed	38” Barbed
2nd wire	28” Barbed	22” Barbed	26” Barbed
3rd wire	22” Barbed	16” Barbed	18” Barbed
4th wire	16–18” Smooth	10” Minimum Smooth	10” Minimum Smooth

(Left) Allowing 12” between the top two wires reduces the risk of wildlife getting legs caught up in the wires.

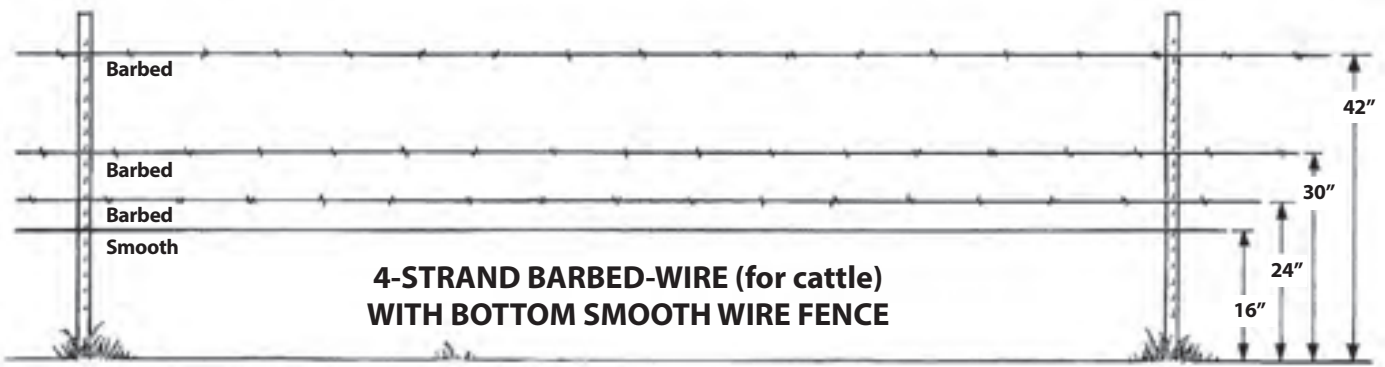

High-tensile Fence

Landowners installing wire fences may want to consider using only high-tensile wire. Wildlife is less likely to get hung up in or damage high-tensile fence. Each strand of high-tensile wire is very strong; 12.5-gauge wire will not begin to elongate until 1,350 pounds of pressure is placed on it and it has a breaking point of about 1,650 pounds. Deer or elk hitting a tight fence are very unlikely to get caught or tangled. The fence is impervious to other events that would damage a traditional wire fence. If a tree falls on the fence, the fence simply springs back after the tree is removed.

High-tensile fence is considerably less expensive to install and maintain than barbed-wire. The line posts can be spread up to 100 feet. That means less cost for posts and less work setting posts. Also, there is no need to tie off at

A simple ratchet tool allows the landowner to adjust each strand of high-tensile wire as needed.

corners because the wire goes around them. High-tensile will expand with the summer heat. Simply use a ratchet handle to put additional tension on each strand. In the



PHOTO BY WENDY HANOPHY



PHOTO BY PAT TUCKER, CPW

An electric fence can be placed between pastures to contain livestock and allow wildlife to cross.



PHOTO BY PAT TUCKER, CPW

winter, the same tool is used to reduce the tension slightly. This is the only maintenance a high-tensile fence will need. Also, studies show that high-tensile resists rust for up to 50 years!

Seasonal Electric Wire Fence

A flexible electric fence that allows passage for elk and other ungulates can still be effective for livestock. Livestock should be trained to the fence before use. It can be laid down seasonally to allow free wildlife passage. This fence is useful for keeping stock out of sensitive habitats or for short-duration grazing where permanent fencing isn't desired.

- Pre-drill 72" x 1" heavy fiberglass posts;
- Drive posts 24" into the ground at a 32' spacing (a t-post pounder can be used if ground is soft);
- Use treated wooden posts for bracing at ends and center;
- Place a top wire of conductive high-visibility tape, braided wire or polymer-covered wire no higher than 42", electrically charged (medium tensile 12-gauge plastic coated wire is satisfactory);
- Place a second grounded strand of high-tensile wire at 30";
- Attach strands to fiberglass posts with wire clips that can be removed when fence is laid down;
- Use insulators for attaching hot top wire to wooden posts; grounded wire can be stapled or clipped directly to wooden posts;
- Use a solar electric energizer (size and placement depends on the run length of fence).

To work properly, this fence needs to flex as elk and other animals pass over it. Install as few rigid post supports as possible, and use the minimum recommended wire tension. Placing the energizer toward the middle of the fence will afford the greatest electrical efficiency.

Moveable Electric Wire Fence

A temporary electric fence can be used to keep stock out of sensitive areas such as wetlands and can be easily crossed by most wildlife. A moveable electric fence is best used for short-duration grazing or for other situations where livestock need to be temporarily controlled. This fence works well for stock that has been trained to avoid electric fences.

The design can be tailored to your situation, but a simple fence can be constructed using high-visibility tape or "turbo wire" and fiberglass posts or plastic-insulated steel posts. A moveable fence can use either a single hot wire (when there is sufficient moisture for an adequate ground) or two wires, the top one hot, the lower wire grounded. Moveable posts on the market include designs with hooked or pigtail tops for quickly stringing wire, and a tread-in foot. These can be rapidly set up and moved as needed.

- Use 40"–42" fiberglass or plastic-insulated steel posts, designed with hooks or loops for wire and tread-in spikes at the foot; Place one to two strands of high-visibility tape or polymer-covered turbo wire;
- If two wires, make the top wire hot, the lower wire grounded. Top wire should be no higher than 42"; lower wire no lower than 16";
- Use a solar electric energizer (size and placement depends on the run length of fence).

The New “REAL” Fence

Clyde Greer’s wife Carol’s family has been on land near Springfield, in southeastern Colorado, quite a while. The McEndree family homestead had grown from the original 320 acres to 24,000 acres of shortgrass prairie by the 1970s. In a region known for erratic weather, high and dry often describes more than the landscape. It’s a tough place to make a living.

“There’s no normal, no average,” says Greer. “One might need 30 acres for a cow in a good year and 60 acres in a bad year. Depending on the year, the land could yield anywhere from zero to 60 bushels of wheat.”

Carol’s mom was born in 1900 and moved to the homestead in southeast Colorado in 1908. She married Carol’s father in 1920. Together, they raised six children, cattle, sheep, horses, and wheat. Carol and Clyde met at CSU and settled in Bozeman, Montana. Clyde was a professor of agricultural economics at Montana State University (MSU) and Carol managed the Native American Studies Department.

The ranch was split in 1991 after Carol’s parents’ deaths. There was a lot of work to be done. Many of the fences were forty to fifty years old and too brittle to be repaired. New fence would be incredibly expensive. As luck would have it, Greer had a student at MSU, Brooks Emeny, who was installing high-tensile electric fence on large properties in Wyoming and Montana. Greer was open to suggestions—to a point. Like most ranchers, Greer and his wife’s relatives trusted what they knew.

Because of the cost Clyde decided to give a new design a try—“sort of!” His brother-in-law informed him that if he tried the electric boundary fence, he was on his own. The first “experimental” high-tensile fence that Greer installed about .75 mile from the homestead had four wires evenly spaced and posts placed every 33 feet. “That way,” says Greer, “I could

go back and put another post in between and build a REAL fence if it didn’t work.”

But it worked! Maintenance has been minimal. Clyde has not even had to tighten the wires in the fence since the second spring—2002. The 4-wire high-tensile electric fence cost about 60% of what a traditional barbed-wired fence would have cost when it was installed in 2001. He used 12.5-gauge, Class III galvanized wire, with a tensile rating of 200,000 psi.

Greer uses fin tubes as insulators and the smaller 1.25” “T post.” If the fin tube goes bad, he simply unclips it and flips the tube over.

Greer clips fin tubes to narrow steel posts as insulators.



PHOTO BY WENDY HANOPHY

Greer was emboldened to try installing the 3-wire fence that Emeny recommended, but he could not afford to replace much of the old fence. When Greer learned about cost share programs of EQIP (the Environmental Quality Incentives Program) available through the Natural Resources Conservation Service (NRCS), he applied. NRCS requires new fences to be amenable to wildlife. Greer has mule deer, turkeys, and pronghorn on his property, with an occasional bear and elk sighted in the area.

He began by replacing broken boundary fences with high-tensile electric 3-wire fence. The top and bottom wires are hot and the wires are placed at 22”, 28”, and 40.” No cows have crossed the fence and it seems highly durable. When they had 4.5 feet of snow in a storm in 2007, Greer found only three broken wires in 19 miles of high-tensile fence he and Carol’s nephew, Steve McEndree, had built since the first try in 2001. Repair was a quick splice with a crimp sleeve. In contrast, the bottom wire of an older 4-strand barbed-wire fence needed splicing at every fourth post.

2-wire electric fence is used to separate pastures.



PHOTO BY WENDY HANOPHY

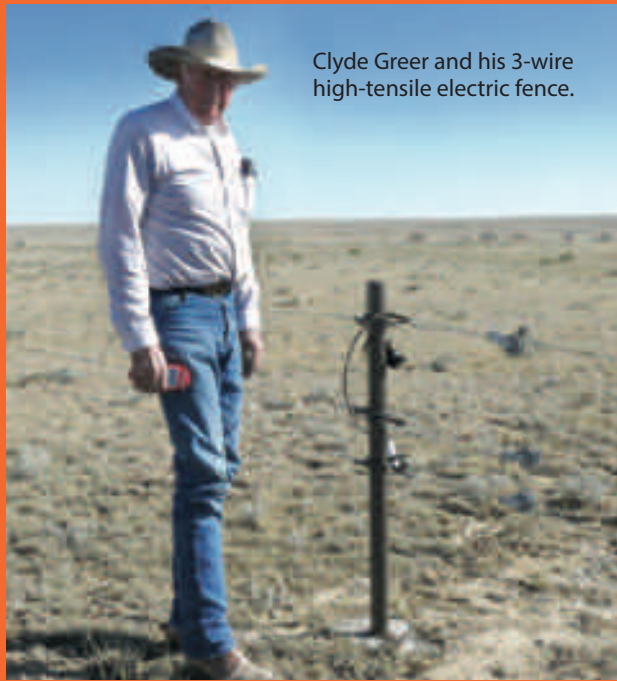

Clyde Greer and his 3-wire high-tensile electric fence.

PHOTO BY WENDY HANOPHY

Once the boundary fences were in place, Clyde began fencing off pastures for rotation grazing. For interior fences, he uses a 2-wire design. The bottom ground wire is at 26” and the top hot wire is placed at 32.” For posts, wire, and his fin tube insulators, the materials for the two-wire electric fence costs about \$9 per hundred feet. Pipe corners set in concrete, pipe gates, machine time, and a solar energizer raise the out-of-pocket costs to slightly over \$40 per hundred feet. Two-wire fence is very economical, but can it do the job? Do the cows respect the fence? So far, in Greer’s experience, they do.

“Usually” says Greer, “Yearlings make trails by the fence. The first summer that the 4-wire was put in, there was no trail. They sense the electricity. They made a trail along the barbed-wire that quickly dissipated when they reached the electric wire. The same is holding true along 2-wire fences.”

His favorite story of the power of his two-wire fence might convince the most die-hard skeptic. Some cows were still calving at Butte Creek last fall when Steve and Clyde wanted to move the herd. They left behind two cows and two calves at the creek bottom. When Greer checked on them in the following days, he still had two cows and two calves but he noticed that one calf was not allowed to suck either cow. Something was definitely amiss. He observed that one cow glanced up at the bluff. He took his ATV up the bluff and found another calf. He loaded the calf on his 4-wheeler and went looking along the fence for another cow. He found a place where a cow came by

a few times, but didn’t cross the fence. He took the calf down to the water trough. His mama came barreling up to the fence but wouldn’t cross it. Greer got them back together at the gate.

When Greer completes his third NRCS contract, there will be no pasture bigger than half a section unfenced. He says he’s gone from one extreme to another to test rotation grazing in the area and has built windbreaks and fenced wildlife areas. He’s pretty much sold on the electric high-tensile fence designs. He says that NRCS is very happy with the results of the past seven years. Even though 2000–2009 was the driest decade on record, there is good grass regeneration and forbs are coming in. Being an economist though, Greer is concerned about the long term. “I won’t live long enough to see the outcome of all of this. I’ll consider it a success if the kids can take the records to the bank and get financed.” Still, he’s ready to remove two wires from his first experimental fence. He’s beyond trusting only the familiar. He has a philosophy of fences that applies to any area in life. “I know I can get into a rut and be absolutely wrong.”

Clyde Greer and another of Carol’s nephews, Tom Wallace, have been sharing their successes using high-tensile electric fence at CPW landowner workshops. Clyde has a pretty dramatic method of teaching the difference between high-tensile and high tension. “High-tensile is low tension,” says Greer, “There is no elasticity in wire.” In one landowner workshop, Clyde asked a particularly outgoing neighbor to hold a portion of tightened fence while he cut through it with bolt cutters. The neighbor refused. Greer then offered to hold the fence while the neighbor made the cut. Again, the neighbor refused. After much discussion, the neighbor was willing to cut the fence. Clyde’s grip parted several inches, but he wasn’t flung off into the hinterlands or injured by the fence. Point made, point taken, in a highly successful workshop.



PHOTO BY KEN MORGAN, CPW

Worry-free Water Gaps

You won't catch Clyde Greer talking negatively about rain. After all, this is the first year after a decade of drought that they've had "normal" precipitation. On most ranches though, rain does bring work, and a job that's usually necessary after a heavy rain is fixing water gaps. Water gaps exist at points where a fence crosses a creek or draw. Traditionally, sections of barbed-wire fence placed in these areas are designed to break loose if the water flow is too high. That way, the high water and large debris rushing through wipes out only the small section of fence where the water gap exists, which is much easier to fix than a large section of fence. After a heavy rain, most ranchers and cowboys spend the next day or two "water-gapping"—that is, repairing the gaps that have been washed out.

Not Clyde. He doesn't worry about "water-gapping" anymore. His electric water gap works extremely well. His main fence power wire is high enough to be protected from water and debris. His bottom hot wire has smooth wire streamers that hang down to the bottom. The vertical wires do not catch trash—the debris just flows through with the water. To prevent a short, the bottom wire has an automatic cut out switch that cuts the power to the wire going down into the gap as soon as water hits it. This prevents killing the power to the main fence.

The system works extremely well. During the last rainfall, water filled and then flowed over the banks of the creek. What was Clyde doing the following day? Other than smiling a lot, he drove out to the fence with his trusty digital volt meter to test the grounding systems and check for shorts. He didn't spend any time walking downstream looking for

runaway fence, setting posts, or untangling and stretching wire. There was no need. His electric water gap functioned perfectly.

Like any stretch of fence, a careful look at your situation and needs will help you reduce your overall expenses for a water gap and cut down on time spent repairing it. There are a few things to think about before putting in a water gap. The first thing is how much trash, such as big trees falling off the bank, logs, etc., will be flowing through the gap. Basically, what is upstream? This will determine if you want to construct a permanent or a break-away water gap.

Second, is there access to a source of power for electric fencing purposes? If you rarely have livestock in the area, you might be able to run a single wire across an enormous water gap in a short period of time, hang some vertical wire and be done with it.



PHOTO BY PATTUCKER, CPW

Anchor posts in flood-prone areas with rock or concrete.

For gaps with very little water flow or occasional flooding, a more traditional "permanent" water gap can be constructed. The flooding breakaway section should have its own brace posts. The posts in the creek or gully can be driven in or anchored with rock or concrete. Some landowners have filled old tires with concrete, placed a post or sucker rod in each, and then connected the wire.



PHOTO BY WENDY HANOPHY

High water and debris cannot damage Clyde Greer's water gap. Water and trash pass through the vertical smooth wire.

3-Wire High-Tensile Electric Fence

Researchers in Wyoming found that a 3-wire high-tensile fence (with a hot—ground—hot configuration) is not only effective for containing cattle and bison, but allows elk, mule deer, and pronghorn to traverse the fence. They found that wild ungulates usually were not deterred by electric fences—perhaps because of the insulating properties of their hair. Although wild ungulates were occasionally shocked when they nosed or bit a wire, or touched hot and grounded wires together, most animals readily negotiated the fences. Further, the researchers determined that 3-wire fences effectively contained bulls separated from cows coming into estrus, and calves from cows in the fall. Also, they found that a 3-wire fence was just as effective for containing bison as a 4-wire fence. A 2-wire fence can be used for areas without weaning calves but, curiously, pronghorn showed a high aversion to 2-wire fences, perhaps because of the novel height and their general reluctance to jump fences rather than crawl under (Karhu and Anderson 2003, 2006).

High-tensile fences require proper construction techniques, including adequate braces, proper tensioning, care not to kink or break wire, and proper attachments and insulators for posts and braces. However, high-tensile fences need minimal maintenance, provide great strength, can be easily electrified and will outlast most other fences.

- Maintaining fence flexibility is key to allowing wildlife to traverse the fence;
- Use fiberglass posts no greater than 1” in diameter;
- Brace fence with wood posts at least 5” in diameter; use braces at all corners, gates, and direction changes greater than 15 degrees. Appropriate insulators are needed with wooden posts;
- Space posts at a minimum of 50’ apart if stays are used, and maximum of 50’ apart with no stays;

- Fence stays can be problematic, making it harder for wildlife to pass between the wires, sometimes causing the fence to flip and twist when wildlife cross, and increasing the risk of grounding out the fence. If stays are used, the free span should be at least 30’ for wildlife to cross effectively;
- Smooth, 12.5-gauge, Class III galvanized wire with a tensile strength of 170,000 PSI and breaking strength of 1,308 lbs. is adequate. To increase visibility, for the top wire use white poly-coated wire with the same specifications;
- Space wires at 22”/30”/40–42” from the ground. The top wire should be no higher than 42” with 10 to 12” between the top and middle wires. A bottom wire at 22” allows both young and adult wild animals to pass under easily. Connect wires to posts with metal clips or fasteners designed for electric fences;
- Top wire is hot; second wire is grounded, bottom wire is hot;
- Tighten wires to 150 lbs. tension. If too tight, the wires are more likely to break. Although high-tensile wire has a high breaking point, it is also more brittle, and easily broken if tightly bent or kinked;
- Place solar energizer according to manufacturer recommendations;
- Ground fence properly according to the energizer instructions, and add extra rods as needed. Locate ground rods at fence ends and intermittently in between;
- Keep fence electrified even when livestock are not present to prevent wildlife damage to fence. This also prevents the battery from freezing and prolongs battery life;
- Securely attach electric fence warning signs intermittently along the fence and at crossing points.

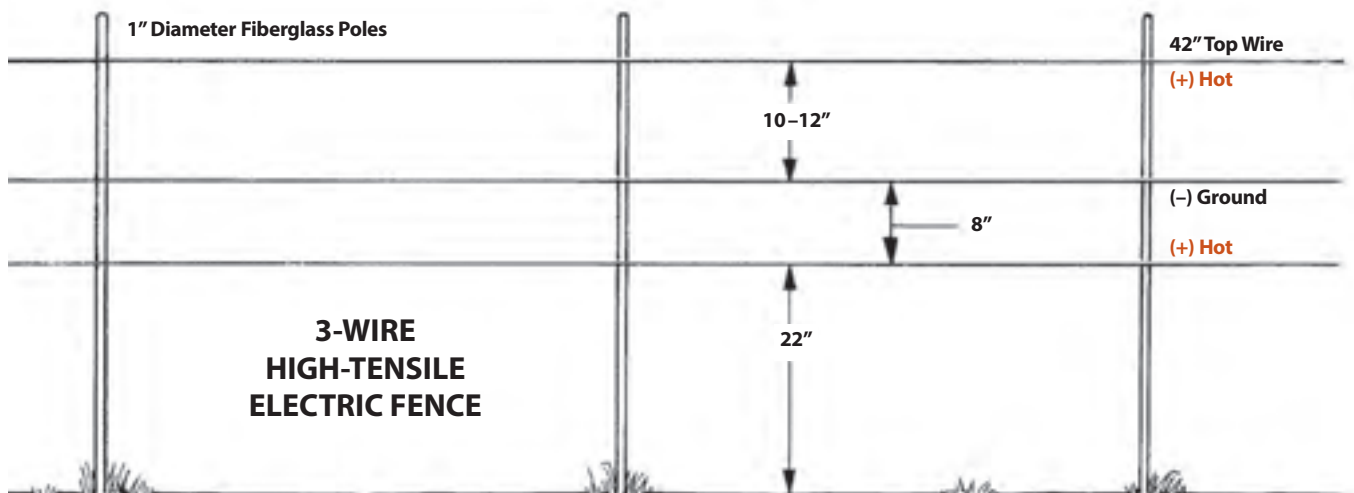

Post and Rail Fence or Post and Wire Fence

A post and rail fence is one of the more expensive fencing options and presents unique problems for migrating elk and deer. Fawns and calves have significant problems crossing these fences because they cannot jump high enough and cannot fit through or under them. Construct rail fences of three rails or fewer. A two-rail fence is preferable. Boards or planks should not be used as these can create a visual barrier. Limit fence height to 42" and provide 16" clearance between rails for younger animals to pass through. Place the bottom rail at least 16" above the ground.

Rail fences can also use a top rail with wires below. Place smooth lower wires at 16" and 28" above the ground. The second wire should be at least 12" below top rail.



PHOTO BY PATTUCKER, CPW

Jackleg Fence

Traditional jackleg fences are popular where the ground is rocky, lodgepole are plentiful, and where it is difficult to dig or drive posts. These fences are attractive but their widespread bases make it difficult for wildlife to clear. While deer and smaller animals can crawl through the jackleg rails, elk and moose often run parallel to the fences for long distances before leaping. If the fence is next to the highway, it can trap animals in the right-of-way longer than necessary, increasing the likelihood they will be struck by cars. A jackleg fence intended to identify

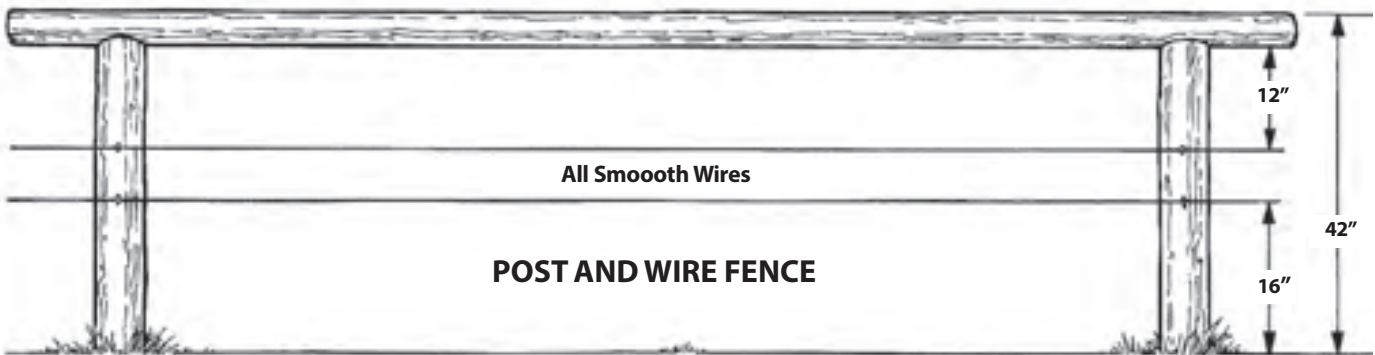



Worm or zig-zag fence is often used on rocky or uneven ground.

property boundaries can be made safe by creating a few well-spaced gaps. Sections of fence can be built with lay-down rails that are dropped in the places where animals are most likely to cross.

Worm Fence

Worm fence is simply constructed of rails stacked alternately on top of one another, with the rails interlocked like laced fingers where the ends meet. The fence zigzags to give it stability, and it can be used where posts can't be driven into the ground. These fences are usually only two to three feet high, and are most often used in mountainous areas where local timber is readily available and the terrain tends to be rocky and uneven. If you use a worm fence, create openings for wildlife to cross by intermittently dropping rails to the ground every 400', and in swales and at stream crossings for easy wildlife passage.

Need a Stronger Fence?

In most situations, a three or four-strand barbed-wire fence, a combination of smooth and barbed-wire, or a high-tensile electric fence will work well for livestock control, particularly if the pasture quality inside the fence

is as good or better as outside the fence. Stronger, more impermeable fence may be needed to control sheep, bison, or large bulls, or to separate bulls from cows in estrus, or separate cows from calves. There is no "one size fits all" solution, but these tips will help reduce the impact of your fence on wildlife:

- Consider seasonal fencing and remove the fence when it is not needed. In permanent fence, install lay-down or drop-down sections or gates to open the fence during months when stock is not present;
- Limit the extent of impermeable fence whenever possible;
- Avoid excluding wildlife from stream sides and water sources, or cutting off migration and travel corridors;
- If your fence height must exceed 42", create periodic crawl-openings for fawns and calves by raising the bottom 16" from the ground, placed where wildlife typically travel;
- Avoid topping woven wire fences with barbed-wire. In any situation, allow 12" between the top wire and the next wire below—whether barbed or woven wire.

Fencing for Horses

Horse fencing options are as varied as those for cattle and sheep. From traditional wood post and rail fences to high-tech plastic fences, all have their advantages and disadvantages to wildlife and to the landowner. Post and rail, post and wire, buck and rail, and many of the fences already mentioned can also be used to contain horses. The same “wildlife-friendly” rules apply. Limit the height of the fence to 42”; that really is adequate to keep in nearly all breeds of horse. Keep the bottom rail, pipe, or wire at least 16” from the ground.

Post and Rail Fence

Wooden post and rail fence is a traditional variety of horse fence. Horses can and will break rails and boards and can run through a wood fence if spooked. If the rails are nailed on, nails can become a hazard if they come loose and a horse accidentally steps on them. Many horse owners use a strand of hot wire on the top rail to discourage pushing on the wood or chewing on it.

Rail fences can allow for wildlife passage.

Pipe Fence

Pipe fencing has become very popular horse fence in many parts of the country. It is attractive and highly visible to both horses and wildlife, and minimizes the chance that an animal will collide with it. It’s more expensive to install than post and rail fence, but once up there is little maintenance and it lasts a long time.

Vinyl or PVC Fence

Some people choose vinyl or plastic fences to enhance the look of the property. It is highly visible and attractive and comes in a variety of colors and styles. Horses don’t chew on it. However, using this type of fencing has some significant downsides. Not only is it very expensive, horses and wildlife can pop the rails out if they push on them. Plastic fences don’t hold the horses well. If you’re planning on running horses in a pasture using vinyl fence, run a strand of hot wire on the inside of the top rail to discourage horses from pushing or leaning on the rails.

Tubular Panels for Portable Horse Fence

When temporary horse fencing is needed, consider tubular panels. They are easy to install and move around



PHOTO BY PATTUCKER, CPW

(Right) Horses can and will break boards and rails of wood fence and pop out rails of vinyl or PVC fence.



PHOTO BY PATT TUCKER, CPW

(Below) Horses cannot see standard electric wire very well. Choose a highly visible braided electric wire for enclosures .

and provide a lot of flexibility to the horse owner. By temporarily creating a small paddock or pen, you can contain horses and allow wildlife unlimited access.

Pipe-and-Cable

Pipe-and-cable is a common fence option that poses some risk. Horses and wildlife can get caught in the cable, which causes serious injuries. The pipe needs to be sanded down and repainted every few years to prevent rust. When the cable rusts, it becomes very brittle.

Electrifying the Fence

All fences can be electrified. Often a single wire is installed just inside or above the rest of the fencing to prevent horses from touching or leaning over the fence. Using electrified wire on its own can pose safety issues. Horses don't see the wire and they can get caught up in it easily. If you want an electric



PHOTO BY PATT TUCKER, CPW

fence, choose one of the electric braid options on the market. Electric tape can be used with other fences or as a temporary fence by itself.

Openings, Crossings, and Passes

Openings and crossings can be placed in fences to allow wildlife to pass when livestock are absent. Openings keep fawns and calves from being stranded, allow passage for animals unable to jump fences, and help wildlife cross when snow hinders passage over or under fences. Wildlife crossings are especially important when fawns and calves are small and during seasonal wildlife migrations. They can considerably reduce wildlife damage to fences and decrease maintenance costs. The local topography and patterns of wildlife travel will help determine the placement of crossings. Look for signs of wildlife use and travel such as tufts of hair caught on fence wires, game trails, trails to water, or gullies and swales that act as wildlife corridors.



PHOTO BY PAT TUCKER, CPW



PHOTO BY PAT TUCKER, CPW

Removable Fence Sections and Gates

Fences can also be barriers to seasonal migration. By simply removing sections of fence or opening a strategically located gate, you can help elk and deer herds move between summer and winter range and calving grounds.

Dropped Rail

Jackleg fence, post and rail fences, and worm or zigzag fences may be difficult for some animals to negotiate.

An occasional gap in the fence can provide a crossing. Animals will often move along the length of a fence seeking an opening. Simply dropping the rails to the ground every 400' will allow animals to step across. Rails should be dropped where there are signs of wildlife passage, such as game trails, and in stream corridors, gullies, or other natural funnels.

There are various design options that allow rails or sections of fence to be removed to allow passage for elk and deer.



PHOTO BY PAT TUCKER, CPW



PHOTO BY PAT TUCKER, CPW

DROPPED RAIL FOR WILDLIFE JUMP

For a specific area,
not for the entire fence.

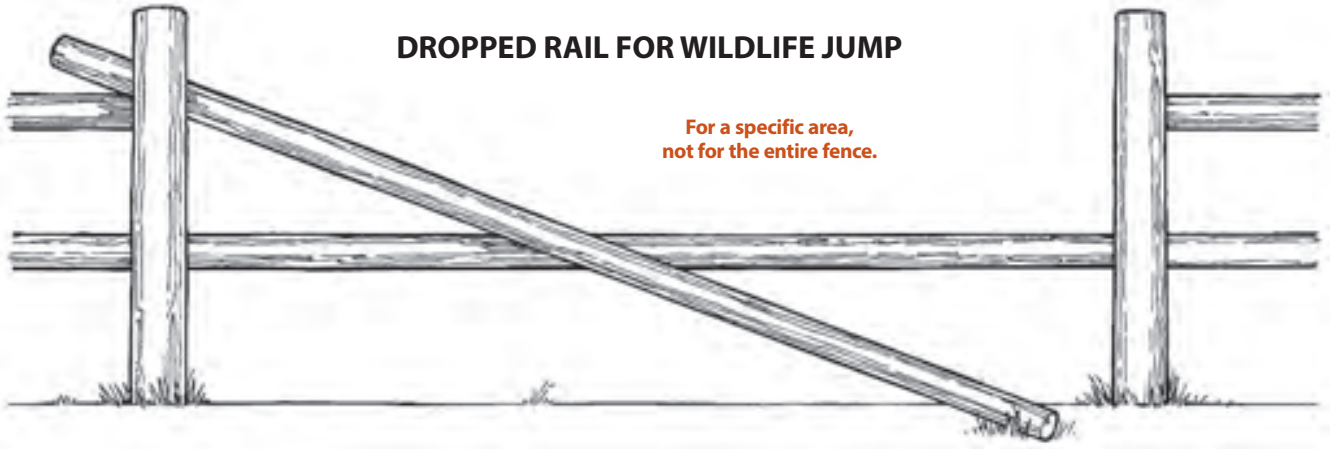

DROPPED RAIL IN JACKLEG

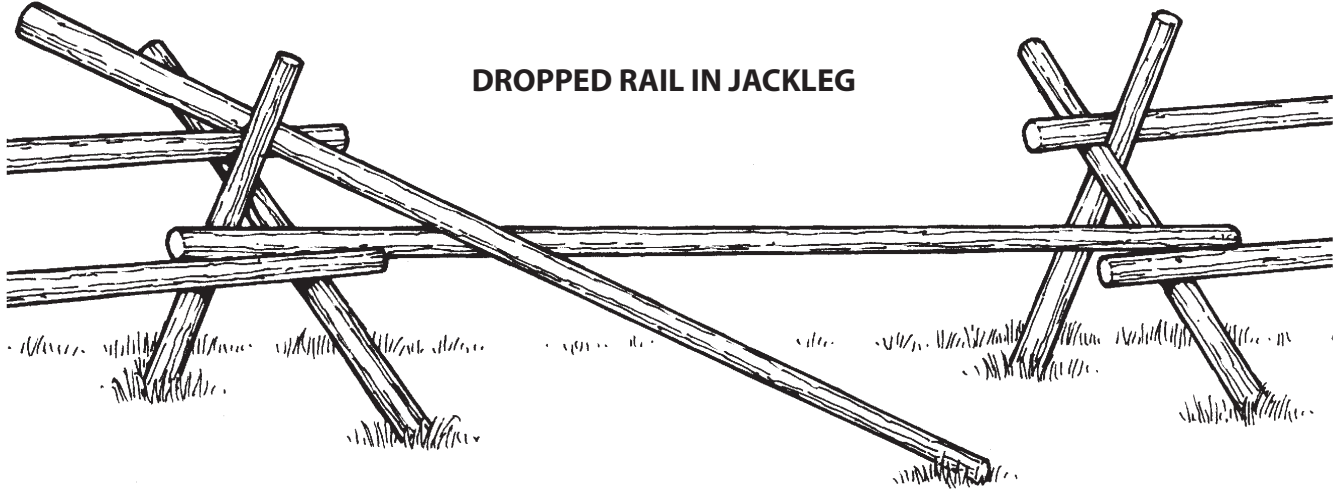

Wildlife jumps
can be placed
in traditional
barbed-wire
fence.



PHOTO BY KELLY CRANE, CPW

Ramps

The Colorado Department of Transportation (CDOT) has been building ramps for wildlife along the state's busy highways. The ramp is a vertical wall on the livestock side. If elk or deer are on the highway, they can run up the ramp and jump off the backside.

A CDOT elk jump alongside Interstate 70.



PHOTO BY PAT TUCKER, CPW

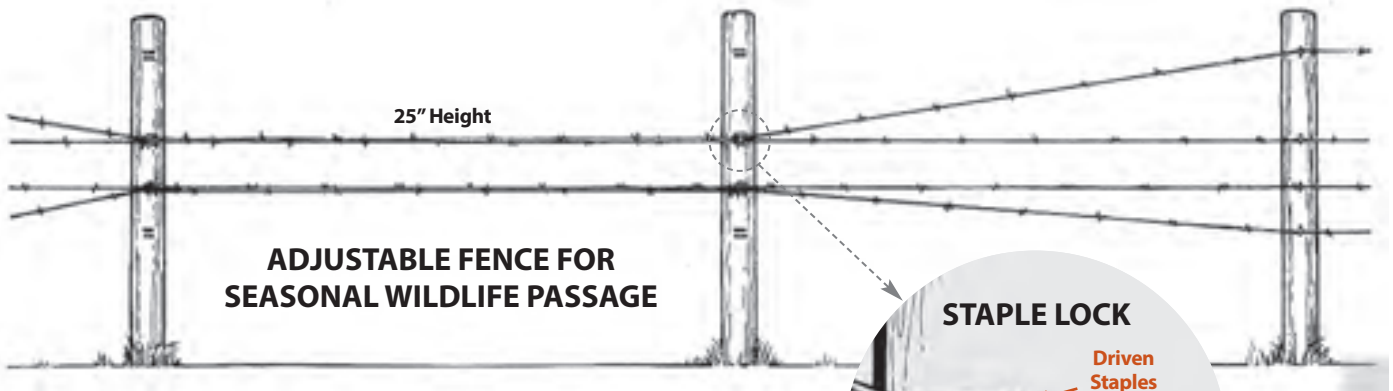

Adjustable Wire Fence

Adjusting the height of one or more wires is an easy and effective way to allow animals to cross during migration periods if livestock aren't present. Existing fences can be readily modified by installing staple locks to create a drop wire so that the wire height can be adjusted. Drop the top wire to the level of the second wire, either in sections or along an entire run of fence, to allow wildlife to jump over easily.

Lowering the top wire to 25" or less allows elk and deer to hop over easily in almost all conditions. Raise the lowest wire in the same way to help wildlife crawl under. A simple staple lock allows wires to be rapidly adjusted from one level to another and the wires can be easily adjusted by only one person.

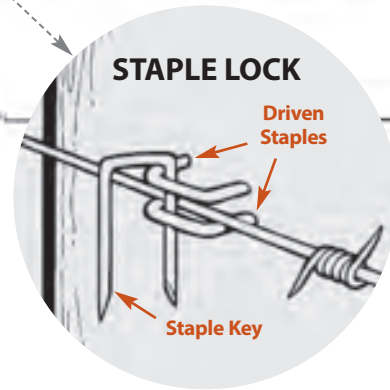

Staple lock for wooden posts:

- Install two fence staples horizontally and less than an inch apart on each post at the level of both the top wire and the second wire;
- Slip the fence wire between the two staples;
- Secure it in place by hooking a third staple through the paired staples vertically, like a latch.

Lake County Leads in Elk Friendly Fence

What would you call a collaboration that enables a ranch to continue producing cattle and preserves wildlife habitat and recreation along one of the most scenic stretches of the Arkansas River? What would you call a county that could do this twice? And what would you call a few stretches of fence that make it all work? We call Lake County, the landowner partnerships, and a few fences magnificent.

The Hayden Ranch

Founded in 1859, historic Hayden Ranch is one of the oldest mountain ranches in Lake County. It lies just south of the town of Leadville, nestled at the base of Colorado's two highest peaks. The ranch was a hay operation through the 1890s and later turned to grazing cattle. After 1947, the ranch was rarely used and fell into disrepair. In 1998, the city of Aurora purchased the Hayden Ranch for water rights. Many county residents felt they had lost a treasure. Through the efforts of Lake County Open Space Initiative and the Conservation Fund, Aurora donated 60 acres to Lake County and sold 1,411 acres to the Bureau of Land Management in 2005.

That's where Jeff Williams, BLM Rangeland Management Specialist, Tom Martin, District Wildlife Manager for the Colorado Division of Parks and Wildlife (CPW), and Tim Canterbury, 2009 President of the Colorado Cattleman's Association enter the

story. Jeff and Tom wanted to get cows back on the property to stimulate forage for some 400 elk that use the property as winter range. Tim was called in as a consultant, to recommend pasture layout and rotations. Tim was so intrigued with the project that he decided to put some of his own herd on the land.

Tim and the BLM laid out six pastures for medium intensity rotation. Most of the existing fence on the property was useless. Tim and Jeff decided to keep one permanent 2-strand electric fence between two of the pastures and replace the rest as quickly as possible. They needed a strong fence that could keep the cows and calves in and withstand the impact of elk. Since they were starting from scratch, they decided to try something new. Their innovative design has proved bulletproof.

Several miles of old fence along County Road 10 was removed with help from CPW and Rocky Mountain Elk Foundation volunteers. Construction of the new fence began in 2005 using inmates from the Buena Vista Correctional Complex with the supervision of BLM. They put in a 4-strand wire fence, with smooth bottom wire and a high visibility drop-down top wire. The design uses wood stays rather than wire; they keep the fence from flipping and tangling and hold up better in the snow. Tim and Jeff also decided to use insulators instead of traditional staple locks for the drop-down wire. The insulator pinlocks make for easy movement of wires.



PHOTO BY WENDY HANOPHY

Insulator pinlocks allow easy movement of the top wire.



Jeff Williams, BLM (left) and DWM Tom Martin, CPW work together to ensure that elk and cattle can co-exist on the Hayden Ranch.

PHOTO BY WENDY HANOPHY

Since 2005, approximately four miles of this type of fence has been built on the ranch and Tim and his family have been

Sketch of Hayden Ranch drop-down fence by Jeff Williams, BLM.

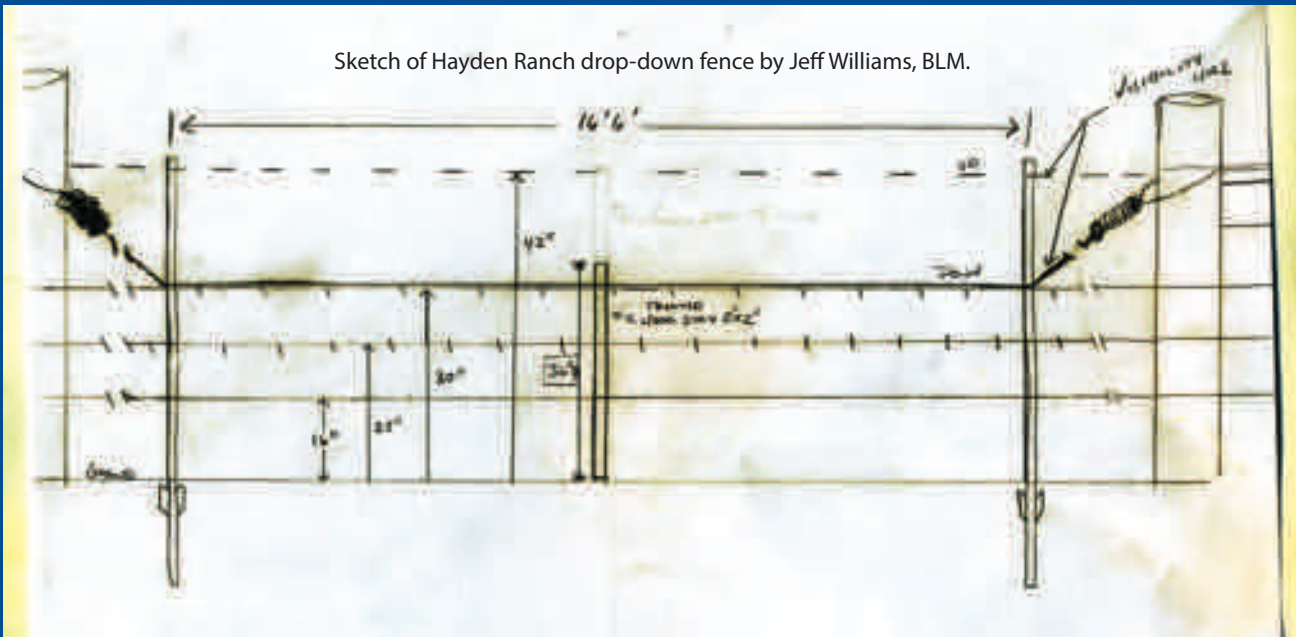

responsible for adjusting the top wire. Says Canterbury, “I can adjust the wires as quickly as I can walk the fence; usually moving a mile of wire in less than 35 minutes.” One small drawback is that rodents seem to chew on the pins if they are left out of the locks. That’s a very small bother. He has not had to repair the fence—not once. Nearly the entire property has the new fence, except for the 2-wire electric and some perimeter fence. That’s probably going to be replaced soon. “Elk don’t see it and go right through it,” says Tim, “Seems like we are fixing it every other week.”

Currently, Canterbury comes in at the end of May to raise the fence to 42” for the cattle coming on June 1, and then takes it down October 1 to 30”. The cattle don’t seem to go to the fence by the county road, so that remains at 30” year-round. He’s never lost a cow

Tim Canterbury



PHOTO BY MARY FERRARO

and has had no wildlife damage, even with about 400 elk using the site. He compares his experience at Hayden Ranch with his experience at his other site in Howard. There are only about 200 elk that go through that property and Tim’s repairing fence all the time. So is the new fence worth the cost? Tim’s sold, “If I would have known, it would be all that I’d have.”

Materials and Cost for Hayden Ranch Elk Crossing Fence (August 2007):

- Gallagher Non-Conductive White Equifence 1,000’ Roll (G910064)—\$150/Roll
- Gallagher T-Post Universal Insulator (G682134)—\$8/Pkg. of 20
- Gallagher HD Tension Spring (290)—\$8 ea.
- Gallagher In-Line Strainer (210S)—\$4 ea.
- 2x2” Treated Wood Stays—\$4/8’ stick
- 5 1/2’ 133 T-Post—\$3.70/Post
- 6”x8’ Treated Post—\$12/Post
- 4”x8’ Treated Post—\$7/Post
- 12 1/2 Gauge Smooth Wire—\$45/Roll
- 12 1/2 Gauge Barb Wire—\$49/Roll

Estimated Material Cost Per Mile = \$3,800
Estimated Material Cost Per Foot = \$0.72

The Moyer Ranch

Just across Highway 24 from the Hayden Ranch lies the last large working ranch in Lake County. Jim Moyer first started helping with the cattle operation on the ranch in the mid-50s. He rode from Leadville on his bicycle to shovel manure and clean ditches for the privilege of fishing the site's pristine waters. Jim didn't see many elk back then. Elk started using the property in a big way in the late 70s and early 80s and the herd has increased about ten percent a year since then. By the time the Moyers family inherited the ranch from Maxine Reddy, about 400 to 600 elk used the area. A key specification in the inheritance was that the land be maintained as a working cattle ranch. The Moyers also wanted to protect the land and the wildlife, but that was quite a challenge. As Jim said to former CPW Area Manager Tom Spezze during one of his calls, "I like the elk, but could you please just come fix my fence?"



PHOTO BY WENDY HANOPHY

The elk crisscrossed the property everywhere, especially along a draw that spanned County Road 7. For three to four months each winter, the elk crossed the same span of fence twice a day. Jim was patching seven to nine holes just in that spot daily! "When the elk are around, a traditional fence does not exist," explains Jim. He used extra rolls of barbed wire each winter just for repairs to that 30-yard stretch of fence. With a property the size of the Moyer Ranch, it seemed that raising calves and saving elk were incompatible goals.

Given these inherent problems, the Arkansas River Habitat Partnership Program (HPP) committee joined with the ranch to create a fence that would work for both the livestock and the elk. District Wildlife Manager Tom Martin and Jim Moyer used HPP funds to put in elk jumps at critical elk crossings and to build a 4-smooth-wire high-tensile fence around the property. The fence has floating fiberglass stays and is really tight—about 500 lbs. of pressure. It requires double H posts to anchor it. If elk run



PHOTO BY WENDY HANOPHY

Jim Moyer (left) and DWM Tom Martin

(Below left) Elk jumps were placed in areas of frequent elk crossing

through the fence, it might be knocked over, but it can be popped right back up with just a yank. Tom Martin says the fence was a real pain to install. "The conditions were not ideal," says Tom, "This would work better on a property that is pool table flat and straight." That definitely does not describe the irregular pasture shapes, the steep hillsides, and the frequent draws of the Moyer Ranch. Still, Jim Moyer says "I love this fence. In the seven years since we put it in, I've only had about 20 minor repairs that took about 15 minutes each to fix."

What's even better for Moyers is not harming the elk. With the old fence, some elk would invariably get tangled up in the barbed-wire. Even if the animal could pull itself free, it was badly injured. Others were eaten alive by opportunistic coyotes. "It's a drastic change," says Moyers, "I wish I had this fence everywhere on the property."

A short time after this fencing project, Tom Martin brokered a deal with HPP, the Moyer family, the Land Trust of the Upper Arkansas, Great Outdoors Colorado (GOCO) and the Division of Parks and Wildlife to secure a conservation easement on 3,200 acres which provides for hunting and fishing access on roughly a third of the property. In addition, this easement permanently protects the critical big game winter range, migration corridors, and other wildlife habitat that the ranch provides.

Tom also convinced Jim to obtain a stackyard from the Division of Parks and Wildlife's game damage program. "With so many elk, it was only a matter of time before they were in the hay," explains Tom. Better to head the problem off at the pass.

Lay-Down Fence

A lay-down fence is a standard 3 or 4-wire or woven-wire fence that can be laid on the ground as a unit to allow ungulates to pass through during migration or seasonal use. Using a lay-down fence can also reduce snow and wildlife damage and save maintenance costs. Most designs allow a single person working alone to let the fence down or put it back up.

Lay-down fence can be constructed from smooth, barbed, or woven wire. Fence posts can be wooden or steel, but wood is more durable in heavy snow areas. Line braces are needed at least every quarter mile. For smooth or barbed-wire fences, posts should be spaced at 16.5' intervals. For woven-wire lay-down fences, there should be shorter sections between line brace posts and a ratchet-type tightener should be installed for each section.

For any lay-down fence, two stays are needed between fence posts, plus a stay lined up with each fence post. Wire loops, secured at the top and bottom of the fence posts, support the fence stays. The lay-down section can then be dropped by flipping up the top loop and lifting the stays out of the bottom loop.

Pronghorn Underpass

Although capable of jumping even high fences in extreme situations, pronghorn generally prefer to crawl under fences. They will often run for miles looking for fence openings or spots to crawl under a fence, and have been known to die of starvation when blocked by a fence they see as impassable. Pronghorn have the greatest difficulty negotiating sheep fence, which either uses lower barbed wire strands than cattle and horse fence, or is made of woven wire. Pronghorn will readily use any section with a slightly raised bottom wire to crawl under a fence.

A pronghorn "underpass" can be created by raising the bottom strand in selected fence sections. Sheep fence, as described earlier, has wires spaced at 10"/16"/22"/32" above the ground, with the top three strands barbed-wire and the bottom strand smooth wire. To make this fence pronghorn-friendly, select sections and raise the

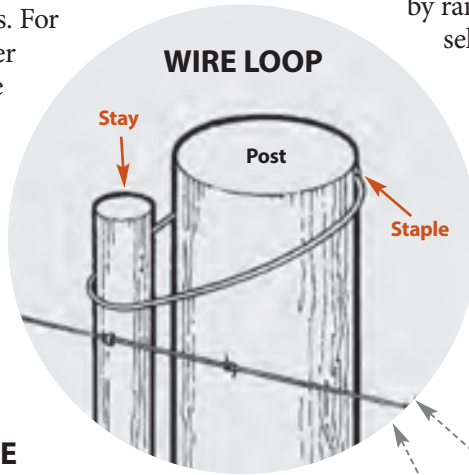

LAY-DOWN FENCE

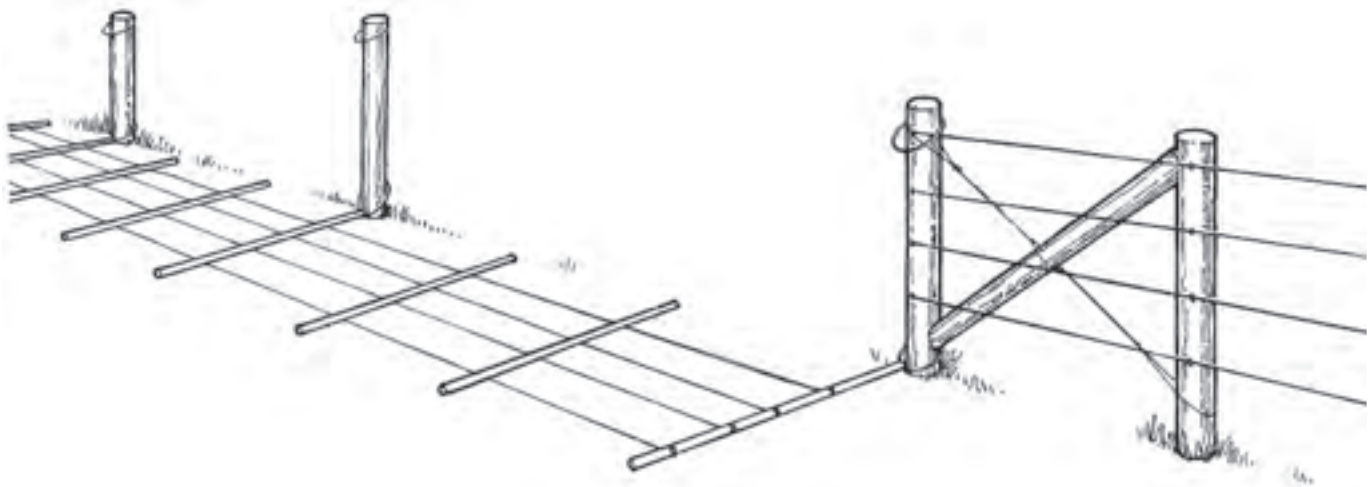
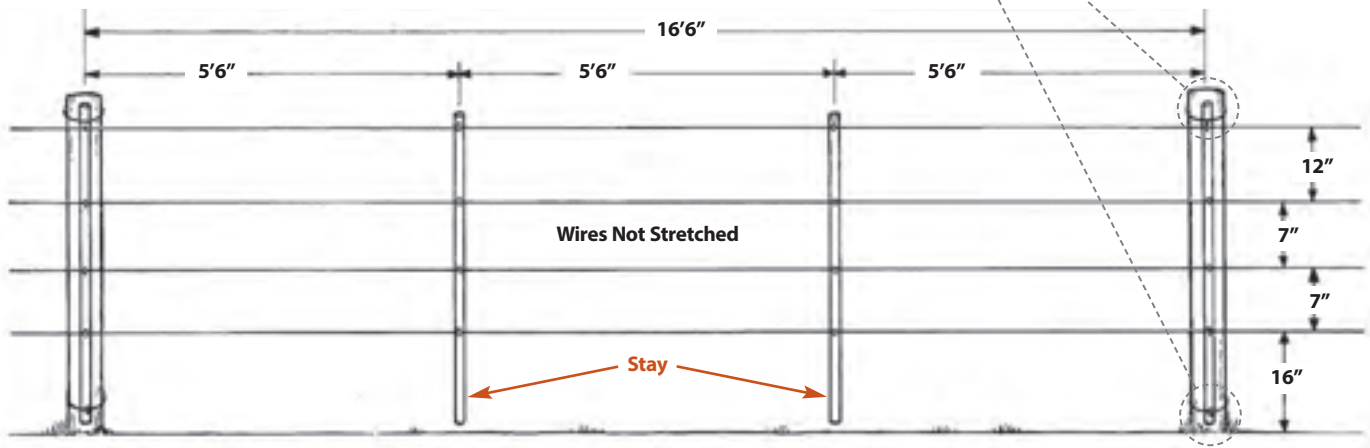

Lay-Down Fence Not a Let Down

Allan Jenkins gives glowing reviews to his year-old lay-down fence. “Last year we didn’t fix wire once—it works for us.”

Born and raised in Walden, Jenkins has been managing much of the Silver Spur Ranch and Cattle Company since 1999. Silver Spur controls more than 60,000 acres, and has allotments on both Colorado State Forest and Routt National Forest. The landscape varies, from the willow-lined bottom of the Canadian River drainage, up through hay meadows and sagebrush, and onto hillsides covered with aspens and conifers. From the beginning of July to the end of September, Jenkins moves cows, calves, and yearlings through the pastures to improve the overall range condition and to prevent damage to riparian areas. He keeps some horses on the ranch as well.

In addition to supporting horses and cattle, the place is a cornucopia of habitat for wildlife. Elk, deer, moose, and pronghorn all wander through. For the



PHOTO BY WENDY HANOPHY

most part, the fences on the property were adequate to allow a peaceful co-existence between the wild and domestic critters. But one segment along the boundary between state land and national forest was subjected to the quadruple whammy—elk, deer, pronghorn, and snow converged each fall to tear that fence down. Often, the weight of deep snow alone was enough to break the old, brittle fence. Once, a herd of over 300 elk barreled through and destroyed the fence.

In the summer of 2008, a one-mile section of the old fence was torn down and replaced with a lay-down section. The lay-down portion has 4-wires, with the bottom wire smooth to allow pronghorn to crawl under. Some also call this type of fencing a “let-down” fence, but not Jenkins. He was thrilled not to have to spend time fixing fence in spring 2009. Instead, he spent about half a day just putting the fence back up. It takes him about four hours to lay the fence down in the fall. The extra work of raising and lowering the fence twice a year is nothing compared to patching the old barbed-wire fence.



Allan Jenkins can take down his fence in the fall in about four hours.

PHOTO BY WENDY HANOPHY

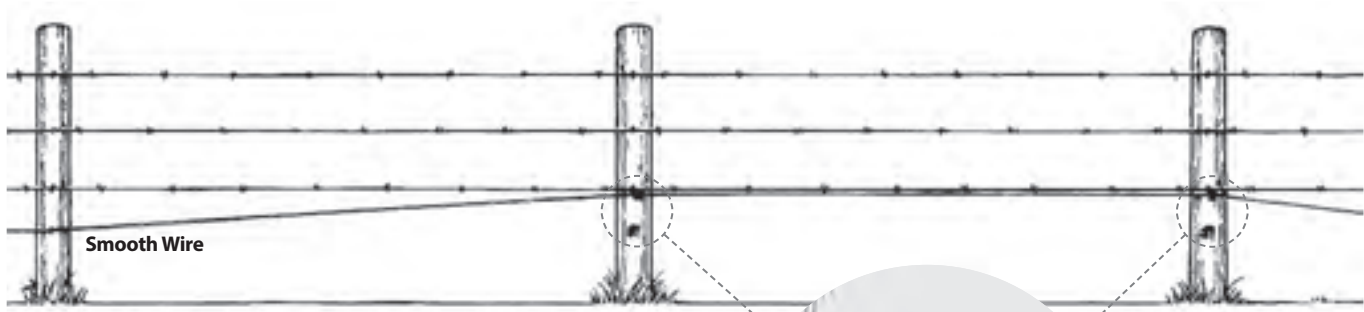

PRONGHORN UNDERPASS FENCE WITH RAISED WIRE

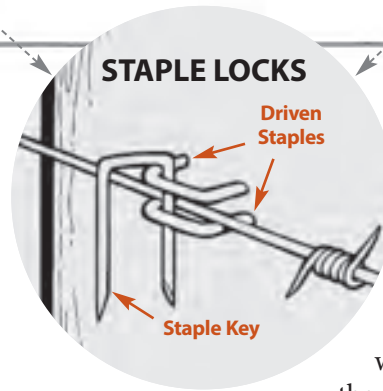

bottom smooth wire on two posts to the height of the third wire, securing it in place with a staple lock. The smooth wire can be dropped again if needed.

Fences in cattle country can be modified in a similar manner or by simply gathering the bottom two wires in a PVC pipe to make a higher clearing for pronghorn of any age to crawl under. Space these underpasses intermittently along the fence and especially in fence corners where pronghorn may be directed by the run of fence. This design has been used extensively in pronghorn habitat.

- Cut several 6 to 12' lengths of PVC pipe;
- With a table saw, cut a .25" slot the length of each PVC pipe;



PHOTO BY TOM KROENIG, CPW

- Grip the bottom two fence wires together, and feed the PVC pipe onto the wire from one end of the pipe. If the pipe gets hung up on a barb at the fore-end, work barb into end of pipe and continue. Once the pipe has been adequately started, grip the pipe near the fore-end and begin pulling down the length of the wire.

Don't Forget the Humans

While creating places for wildlife to pass, take into account where people may need access. This is particularly important if you are using public lands. Gates and passes that allow easy access for humans will preserve your fence and promote goodwill.

Also, be sure to brag about your wildlife-friendly fence to neighbors. Point out that not only are you benefitting wildlife, but you are saving money and time—both in repair costs and in finding lost livestock that have escaped from the pasture.

Remedies for Existing Fences

How can you make existing fences more wildlife-friendly? Fence maintenance, modifications and removal can all help wildlife.

Maintenance:

- Keep wires tight. Sagging wires and neglected fences create a hazard for both domestic animals and wildlife. Loose wires can snare animals as they attempt to cross—tight wires reduce the chance of entanglement.

Maintain fences and keep wires tight. Loose and sagging wires are a hazard for wildlife.

Modifications:

- Replace barbed-wire with smooth wire wherever possible. Smooth wire reduces the chance of animals becoming snared on barbs and fatally entangled.
 - Adjust the height of top wire: no more than 42” above the ground;
 - Increase the distance between the top two wires to 12” to reduce entanglements;
 - Reduce the number of wires to three, or at most four;
 - Add a top rail, high visibility top wire, a PVC cover on the top wire, or flagging to increase visibility and prevent entanglement;
 - Raise the bottom wire to at least 16” above the ground to allow animals to crawl under;
 - In selected sections, raise the bottom smooth wire on two posts to 18”, securing in place with a staple lock;
- For pronghorn, gather bottom wires in a PVC pipe to create a “goat bar” underpass;
 - Add wildlife crossings where wildlife trails cross fences by using dropped wires, dropped rails, lay-down fence or underpasses, as described earlier;
 - Provide wildlife access to rivers, streams, wetlands and water holes, and through seasonal migration areas.

Removal:

- Remove old fences that are in disrepair or no longer in use. Remove any unnecessary interior fences;
- Bale and carry away piles of wire. Some recycling centers will recycle old wire;
- Many conservation and volunteer groups are interested in removing fence to help wildlife. Check with local chapters of sportsmen’s groups such as the Rocky Mountain Elk Foundation, Mule Deer Foundation or Colorado Mule Deer Association, 4-H, scout troops, or your local CPW Volunteer Coordinator.

Exclusion Fencing

There are times when it is necessary to fence wildlife out. If you must exclude wildlife, avoid fencing a large area that includes all wildlife habitat. Focus exclusion fences on small areas for specific purposes, such as fencing around gardens, beehives, calving and lambing areas, or haystacks. Keep exclusion fence close to the activity you need protected, and allow wildlife to use other parts of the property or pass through.

Excluding Deer and Elk

A permanent non-electric exclusion fence for deer and elk should be seven to eight feet high. Different designs can be used, depending upon the circumstances.

Excluding Deer and Elk from Gardens and Orchards

For gardens, vineyards and other agricultural plots, 8’ woven-wire fence is often used with posts set at 8 to 20’ intervals, and the wire is brought tight to the ground. Make the top highly visible by using a top rail, high-visibility wire or flagging. Place gates at corners where an accidentally trapped animal is more likely to find an escape.



Excluding Elk (or Cattle) for Ecosystem Regeneration

Researchers in Colorado have been experimenting with fence designs that exclude elk and cattle from sensitive or damaged habitat but allow access for deer and other species. Deer do not have the negative impacts on stands of quaking aspen and willow that elk do. One promising fence design was used to exclude elk from an aspen stand on the MacGregor Ranch, a working cattle ranch adjacent to Rocky Mountain National Park. Ten foot wooden posts

were buried approximately 2.5' into the ground, about 12' apart. Then, 48" woven wire was stapled to the posts so that the bottom of the wire was 20" from the ground. The researchers also constructed four "deer-ladder stiles" with 20" openings between posts on the fence. During the two years the fence was monitored, only one elk was able to breach the fence. No cattle were able to enter the enclosure. It also was apparent from monitoring that the "deer-ladder stiles" were not necessary. Deer, small mammals and even bear were more likely to go under or over the other portions of the fence. This type of fence shows promise both in protecting forests and willow bottoms from elk and protecting sensitive wetlands or damaged rangelands from cattle.



PHOTO BY KEN MORGAN, CPW

This experimental fence near Rocky Mountain National Park excludes elk but allows deer, bear, and other mammals to use the habitat.

Excluding Deer and Elk from Haystacks

Several options exist for protecting haystacks from wildlife damage. These include electric, non-electric, temporary and permanent designs.

Temporary Solutions

Panels can be rapidly installed around haystacks in an emergency situation. It is best to place panels so that the slats run

perpendicular to the ground. When the primary panels are parallel to the ground, elk may "climb" the panels, resulting in injury to the animal and damage to the panels. While panels are presumed to have a normal life of five years, it would be best to address a long-term problem with a permanent solution.



PHOTO BY PAT TUCKER, CPW

Temporary panels provide short-term protection for haystacks. Place panels with slats perpendicular to the ground.

Permanent Fences

Many landowners prefer to protect a large stackyard with a permanent fence. The traditional stackyard fence is at least 8' high and uses woven wire with wood posts or a

Not Quite Ready for Prime Time—Other Temporary Solutions

Other states have experimented with materials other than panels for temporarily preventing access to haystacks. In Montana, they have wrapped haystacks and large bales with heavy-duty plastic mesh netting, such as Deer-D-Fence (distributed in the U.S. by Tizer Lake Distributors, Jefferson City, MT). Haystacks and large bales can be wrapped quickly, and the netting is readily lifted off when not needed. This netting is especially useful in remote settings. In some places, Montana ranchers have used plastic netting as fencing instead of woven wire, and installed it on wood or steel posts using UV-resistant zip-ties. While the plastic is UV resistant and durable, and materials cost is comparable to woven wire, labor costs for fence construction may be greater. Although the mesh would cause little harm to most large animals, it is nearly invisible when erected and should be flagged to be visible to birds.

Temporary electric fences have also been used to deter deer and elk from haystacks. For a temporary fence, lean eight foot 2" x 4's up against the haystack, spaced about 10' apart. String and secure seven wires 10" apart around the fence posts, alternating the charged and grounded strands. Use insulators to attach hot wires to the 2" x 4's. Deer or elk can't jump over this set-up, and will receive a shock if they reach through for hay. Use a poly-coated wire or tape to increase visibility—it is important that animals be able to see the fence.

combination of wood and steel posts. In areas with significant snow depth, use 12' posts placed 10–12' apart and a strand or two of wire above the woven wire. Posts and wire usually have a lifespan of 30 years.

A permanent electric fence, 7' high, is also effective for protecting stackyards from game damage. This fence is constructed with seven strands of high-tensile smooth wire, alternating hot and grounded strands, spaced at 12" intervals.

- Use 10' pressure-treated wooden line posts, 3 to 4" in diameter, driven 2.5' into the ground, and spaced at 30' intervals;
- Use 10' pressure-treated wooden brace posts, 4 to 5" in diameter, driven 3' into the ground;
- Use 12.5-gauge, smooth Class III galvanized wire with a tensile strength of 170,000 PSI and breaking strength of 1,308 lbs. To increase visibility, use white poly-coated wire with the same specifications;
- Space seven strands at 12" intervals, the top wire at 84" (wooden posts require using insulators).



PHOTO BY PAT TUCKER, CPW

An 8' woven-wire fence provides permanent protection from game damage.

Excluding Deer and Elk in Residential Areas

Wooden fence that animals can't see through, iron or steel fencing, and chain link fence are typically used around housing areas. These fences are especially dangerous to wildlife and can create a complete barrier to animals of all sizes, from turtles to moose. If you must use chain link, metal or plank fences, limit their use to small enclosures.

Yard fences and play area fences often do not need to be more than 4' high. If higher, be sure gates are kept secured to prevent animals from finding their way in. For small chain link dog kennels, attach a roof to protect your pet and prevent wild animals from becoming trapped inside. A roof also provides shade and shelter for your pets.

Deer are not comfortable jumping fences with both height and depth, and are wary of fences that are not flat and regular. A staggered picket fence or leaning fence can be an effective deer deterrent. Tall perennials, shrubs and trees can also be placed along a fence to increase the perceived depth of the barrier.

3-D Deer Fence for Orchards, Yards and Gardens

A 3-D electric deer fence is an effective alternative to wood, chain link, or iron fence for keeping deer and elk out of orchards and vegetable gardens. This fence is basically two parallel fences only 36 to 38" apart, the outside slightly shorter than the inside fence. The 3-D fence can be constructed as a permanent fence with

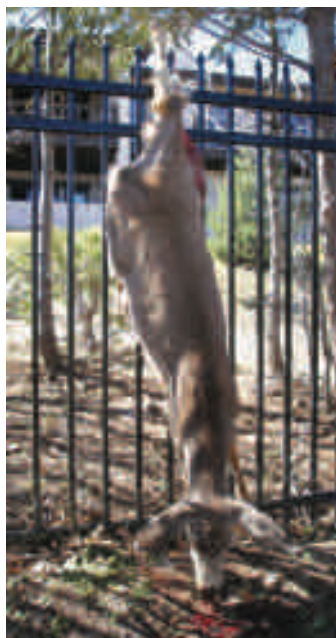

CPW FILE PHOTO

high-tensile wire or as a temporary fence with poly-rope or tape and moveable posts.

- Place two separate lines of 4' fiberglass posts, the lines spaced four to five feet apart;
- Drive posts 16 to 18" into the ground;
- On the inner fence, string two 12.5-gauge high-tensile smooth wires at 12" and 28" above the ground;
- On the outer fence, place two wires at 12" and 24" above the ground;
- Make sure there is at least a 12' clearing in front of the outer fence so deer will see the fence. Flagging or high visibility wire also helps both deer and people see the fence;
- Flagging or white vinyl wire is also essential on the inner fence. That is what deer and elk see and what creates the "depth" that concerns them.

Excluding Bears and Other Predators

Bears, coyotes, bobcats, and other predators pose a fencing challenge to agricultural interests and homeowners alike. Many of these animals are great diggers and climbers, especially when food is the attractant. Ordinary fencing often will not keep them out. In many cases, chain link or woven-wire fence must be buried in the ground or the fence built on a concrete pad. Any doors or gates should include a lock. A roof is also a good idea for those animals that can climb and to prevent hawks and owls coming in from above.

There are a variety of permanent and temporary fencing designs and materials that work in various situations. Since predator problems vary, please ask your local District Wildlife Manager or neighbors about how best to keep your property protected.

Unnecessary, poorly designed, or poorly placed fence in residential areas can be lethal to deer, elk, and other wildlife.

No Bears Allowed

Bob was stung by the beekeeping bug about 30 years ago, learning the ins and outs of his avocation from friend Harold Scherbenski, who he alternately calls “old man” and “Sensei.” To pay it forward, Bob took on partner Michael Hall half a dozen years back. As the years passed, Harold whittled his own collection down to about 45 hives while Bob and Mike expanded to 60 hives. The trio now mentors four to six new keepers at any one time, ultimately keeping their eyes on 200 to 300 hives each year.

Bob, Mike, and Harold are passionate advocates for the under-appreciated agricultural workers in their care. “It’s not just the honey or the wax; bees pollinate 80% of our flowering crops and are responsible for one third of everything we eat,” says Bob. He’s not exaggerating; one Cornell University study estimated that honeybees pollinate \$14 billion worth of seeds and crops in the US annually. They not only pollinate human dietary staples such as apples, broccoli, strawberries, and nuts, but also the alfalfa used to feed livestock.

Beekeeping is no walk in the park. Early each spring, the trio needs to clean up the hives. Then, they coax production by feeding the bees pollen patties to stimulate rearing and encourage colony expansion. They need to make large hives,



PHOTO BY WENDY HANOPHY

A bear took a good bite out of this hive frame.

Left to right:
Darrel Beck, DWM Jason Duetsch,
Michael Hall, and Bob Todd



PHOTO BY KEN MORGAN

with at least four or five “supers” or honey collection boxes, above the brood chamber at the base of the hive.

“A single bee only produces about .0833 (1/12) of a teaspoon of honey in its lifetime,” says Bob. To produce a single pound of the honey, one hive of honeybees needs to rack up 55,000 miles and visit two million blossoms. In a perfect year, with good weather and lots of crops and trees to gather pollen from, one hive can produce around 70 pounds of honey.

In August, just as the hives are most productive, bears are beginning their feeding frenzy, trying to put on a few inches of fat for the long winter. It’s no surprise that bears are attracted to bee hives, each containing a complete diet of protein and carbohydrates. “Bears want the grubs in the bottom box and knock over the hives,” explains Bob, “They will eat honey, bees, everything.”

Bob and Mike have 25 very productive hives on property owned by Darrel Beck. Darrel has been very supportive of their endeavor, giving them a prime location and even letting an adjoining field of alfalfa go to seed for the bees. To be a good tenant and to avoid attracting wildlife, Bob has kept his bee yard really clean. While many keepers throw unwanted burr comb and propolis from the hives onto the ground, he places all of it in a sealed canister.

When Bob heard that a neighboring landowner had some hives destroyed by a bear, he called the Division of Parks and Wildlife to discuss options. District



PHOTO BY KEN MORGAN, CPW



PHOTO BY KEN MORGAN, CPW



PHOTO BY WENDY HANOPHY



PHOTO BY WENDY HANOPHY

Bob Todd's electric fence keeps out bears and smaller pests like raccoons and skunks.

Wildlife Manager Jason Duetsch was Johnny on the Spot, arriving with a fence kit the following day.

“I’ve placed a delicatessen down here by the river, so the bears are not altogether a Division problem,” explained Bob Todd. “It was awfully nice of the CPW to step forward to do this.”

Bob and Mike used some of the materials provided in the kit from the CPW and some materials Bob purchased to design a fence. “I didn’t want to use white plastic pipe because I’m a guest on the property and wanted this fence to fit in with other fences.”

Bob invested in attractive fence posts, smooth wire, insulators and insulating tubing. He combined that with the fiberglass sucker rods, barbed-wire, battery and charger provided by the CPW to build a bear proof—and skunk and raccoon proof—fence. His fence is about 48” high. He placed the bottom wire 6–8” from the ground to prevent smaller predators

from getting in. He was worried that the soil was too dry for a good ground, but so far, the system has worked well. He has three ground rods, driven four to six feet into the ground and spaced 10 feet apart. Bob has jumps to keep alternating wires hot. He’s a bit worried that the top barbed-wire is hot. He’s afraid something might get hung up in that wire—especially himself. He placed a kill switch in a convenient location to keep from electrocuting himself.

While his mentor is impressed with Bob’s work, Harold has a much simpler fence around his hives. He took about half a day to construct a fence using regular steel posts covered with PVC/plumbing pipe. He surrounded that with woven wire that is all hot—charged by a 12-volt direct current car battery. His fence is grounded right into the nearby ditch, which has water flowing year round.

Harold Scherbenski’s simple woven-wire electric fence took half a day to construct.



PHOTO BY KEN MORGAN, CPW

Excluding Beavers

Cylindrical cages are the best way to protect individual trees from beavers. Encircle the tree .5” mesh hardware cloth or 2” x 4” mesh galvanized welded wire. Fences should be at least 3’ high and should extend 2’ above the highest snow level to prevent winter chewing. Install the fence so that it is 8–10” from the plant to allow for trunk expansion. Drive metal rods into the ground inside the fence, and, if possible, bury the fence 3–4” in the ground.

Low fences can be used to protect groups of trees that are close together. Have the fence fit tightly to the ground and monitor often in the beginning for burrowing. If digging occurs, two concrete blocks tied together can be used to block the tunnel.



PHOTO BY PAT TUCKER, CPW

Cylindrical cages are the best way to protect individual trees from beavers.

Getting Help

Colorado Parks and Wildlife

Colorado Parks and Wildlife has several programs to assist landowners and public land managers with fencing issues. These include the Game Damage Program, Habitat Partnership Program, and Private Lands Programs.

Game Damage Program

The CPW’s game damage program provides both temporary and permanent fencing materials for qualified landowners. Restrictions and limitations do exist so landowners should contact their local CPW office for more details.

Habitat Partnership Program

Authorized by the Colorado Parks and Wildlife Commission and Colorado State Legislature, the Habitat Partnership Program (HPP) is designed to help reduce wildlife conflicts with agricultural interests and to assist the CPW in meeting game management objectives on both public and private lands. HPP develops partnerships between landowners, land managers, sportsmen, the public and Colorado Parks and Wildlife to resolve those conflicts.

One of the original purposes of HPP, fence projects remain an important issue for landowners and are an important part of projects approved by local committees. Local HPP committees can consider and help fund new fence projects as well as repairs for existing fences. Most committees will require that fences be built as “wildlife-friendly” so that the original problem is solved rather than re-created. They may also discuss alternative fence options

and designs with the landowner. Local HPP committees may also consider providing stackyards to eligible landowners to protect haystacks.

Since HPP is a partnership, landowners are expected to provide a match to the HPP committee’s contribution. A common match, but not the only one, is when HPP provides the materials and the landowner provides the labor to put them up but this can vary among committees and projects.

Landowners can contact their local CPW office or visit www.cpw.state.co.us for more HPP information.

Private Lands Programs

Colorado Parks and Wildlife partners with landowners to provide funding, resources and technical expertise for wildlife habitat improvement projects. For more information, visit our web site or call (303) 291-7404 and ask to speak with the Private Lands Coordinator.

Natural Resources Conservation Service

Since 1935, the Natural Resources Conservation Service (NRCS) has helped America’s private land owners and managers conserve their soil, water, and other natural resources. NRCS administers several programs through the Farm Security and Rural Investment Act of 2002 (Farm Bill) that may be able to assist landowners with fence design and construction. One example is EQIP, the Environmental Quality Incentives Program, that offers financial and technical help to assist eligible participants install or implement structural and management practices on eligible agricultural land. For information on all of NRCS conservation programs, visit their web site at www.nrcs.usda.gov/programs.

HPP Saves the Hay!

Hay producers and ranchers in Jackson County have a love-hate relationship with wildlife. On the one hand, residents in North Park see big game, birds of prey, and gorgeous songbirds on a daily basis. Their clear, cold streams boast an abundance of trout. They live in the “Moose Capital of Colorado” and the local hospitality businesses thrive on visits from hunters, anglers, and wildlife viewers. On the other hand, several hundred over-wintering elk can devour a lot of forage bound for sale or meant to take the cows through the winter.

Jim Baller knows the problems all too well. A lifetime resident of Jackson County, Jim produces hay and summers about 1,000 cow-calf pairs or 1,600 yearlings on roughly 12,000 acres near Walden. “Hungry elk can consume a lot of hay in an evening,” says Baller. Once, they even had a cow moose with an attitude take apart a few hay bales near the family residence.

To help address these and other wildlife issues, Baller became a committee member of the North Park Habitat Partnership Program (NPHPP). The purpose of NPHPP is to reduce wildlife conflicts, particularly those associated with forage and fences, and to assist the CPW in meeting game management goals. The

local committee is made up of three landowners, a sportsman’s representative, the local CPW District Wildlife Manager, and land managers from the Bureau of Land Management, USDA Forest Service, and US Fish and Wildlife Service. Together, they work for solutions to local problems on both private and public land.

Two of the more successful NPHPP projects are the fence materials supplement program which provides replacement materials for minor fence damage due to big game and the stackyard request program. Jim has utilized both of the programs. He’s replaced old fence with high-tensile fence with a coated top-wire (see sidebar on page 7). Some of the new fence has been up for ten years. Baller reports “I’m more than happy with it. There’s lots of benefit with less maintenance. It works if you put it up correctly and it’s not too high.

I have to stretch wire at the gates three to four times each summer. That’s it.”

Baller says “The stackyard program is important to the local landowners.” The CPW will provide temporary panels to protect hay in an emergency, but Baller explains, “With the deep snow, panels are difficult to use and awkward to move.” It’s key for NPHPP to help provide producers a permanent solution.



Jim Baller

PHOTO BY WENDY HANOPHY



PHOTO BY WENDY HANOPHY

Sources

- **Colorado Department of Transportation 2006 M-Standard (Miscellaneous Standard) Plans**
<https://www.codot.gov/business/designsupport/standard-plans/2012-m-standards-plans>
- **Gillihan, S.W.** 2000. Barbed-wire fence fatal to burrowing owl. *J Colorado Field Ornithologists*. 34(4) 220–221.
- **Harrington, J.L., and M.R. Conover.** 2006. Characteristics of ungulate behavior and mortality associated with wire fences. *Wildlife Society Bulletin* 34(5) 1295–1305.
- **Karhu, R. and S. Anderson.** 2006. The effect of high-tensile fence designs on big-game and livestock movements. *Wildlife Society Bulletin* 34(2) 293–299.
- **Paige, C.** 2008. *A Landowner's Guide to Wildlife Friendly Fences*. Landowner/Wildlife Resource Program, Montana Fish, Wildlife and Parks, Helena, MT. 44 pp.
- **VerCauteren, K., M. Lavelle, and S. Hygnstrom.** 2006. Fences and deer damage management: a review of designs and efficacy. *Wildlife Society Bulletin* 34(1) 191–200.
- **VerCauteren, K., N. Seward, M. Lavelle, J. Fischer, and G. Philips.** 2007. A fence design for excluding elk without impeding other wildlife. *Rangeland Ecol Manage* 60(5) 529–532
- **Wolfe, D.H., M.A. Patten, and S.K. Sherrod.** 2009. Reducing grouse collision mortality by marking fences (Oklahoma). *Ecological Restoration* 27(2) 141–143
- **Wyoming Game and Fish Department.** 2004. *Fencing Guidelines for Wildlife Revised Version*. Habitat Extension Bulletin No. 53. Wyoming Game and Fish Department. 12pp.
- **Wyoming Game and Fish Department.** 2009. *Fence marking to reduce greater sage-grouse (*Centrocercus urophasianus*) collisions and mortality near Farson, Wyoming—Summary of interim results October 26, 2009*. Wyoming Game and Fish Department. 3 pp.



CPW FILE PHOTO

Fences can be hazardous to both mammals and birds; ungulates and low flying birds.



©PHOTO BY SHEILA LAMB



©PHOTO BY SHEILA LAMB

Colorado Parks and Wildlife Offices

Offices and Service Centers

Denver:

6060 Broadway, Denver, CO 80216, (303) 297-1192

Northeast Region Service Center:

6060 Broadway, Denver, CO 80216, (303) 291-7227

Fort Collins Service Center:

317 W. Prospect Rd., Fort Collins, CO 80526, (970) 472-4300

Northwest Region Service Center:

711 Independent Ave., Grand Junction, CO 81505, (970) 255-6100

Southwest Region Service Center:

151 E. 16th St., Durango, CO 81301, (970) 247-0855

Southeast Region Service Center:

4255 Sinton Road, Colorado Springs, CO 80907, (719) 227-5200

Area Offices

Brush Service Center:

122 E. Edison, Box 128, Brush, CO, 80723, (970) 842-6300

Glenwood Springs Service Center:

0088 Wildlife Way, Glenwood Springs, CO 81601, (970) 947-2920

Gunnison Service Center:

300 W. New York Ave., Gunnison, CO 81230, (970) 641-7060

Hot Sulphur Springs Service Center:

346 Grand County Road 362, Hot Sulphur Springs, CO 80451, (970) 725-6200

Lamar Service Center:

2500 S. Main Street, Lamar, CO 81052, (719) 336-6600

Meeker Service Center:

73485 Hwy. 64, Meeker, CO 81641, (970) 878-6090

Monte Vista Service Center:

0722 S. Road 1 E., Monte Vista, CO 81144, (719) 587-6900

Montrose Service Center:

2300 S. Townsend Ave., Montrose, CO 81401, (970) 252-6000

Pueblo Service Center:

600 Reservoir Road, Pueblo, CO 81005, (719) 561-5300

Salida Service Center:

7405 Hwy. 50, Salida, CO 81201, (719) 530-5520

Steamboat Springs Service Center:

925 Weiss Dr., Steamboat Springs, CO 80477, (970) 870-2197

CPW Web Site and Pages

www.cpw.state.co.us

Private Land Programs:

www.cpw.state.co.us/aboutus/pages/privateland.aspx

Habitat Partnership Program:

www.cpw.state.co.us/aboutus/pages/habitatpartnershipprogram.aspx



COLORADO PARKS AND WILDLIFE

6060 Broadway, Denver, CO 80216
(303) 297-1192 • www.cpw.state.co.us

The Colorado Division of Parks and Wildlife is the state agency responsible for protecting and managing wildlife and its habitat, as well as providing wildlife-related recreation. The Division is funded by hunting and fishing license fees, federal grants, and Colorado Lottery proceeds through Great Outdoors Colorado.

2/2015 – 4,000